



LINE: @atipat-thonnawat



ATIPAT-THONNAWAT CO.,LTD

“ INCREASING YOUR SPEED “

ELECTRICAL FITTING PRODUCTS AND ACCESSORIES

CONDUIT AND FITTINGS FOR EMT / IMC / RSC

CONDUIT BODIES AND BOXES

C-CHANNEL AND ACCESSORIES

CLAMP , HANGER AND SUPPORTS

ELECTRICAL CABINETS

WIREWAYS AND ACCESSORIES

HOT DIP GALVANISED FITTING ACCESSORIES



TUV NORD (Thailand) Ltd.

NSC-TIS-TIS 17021-1
QMS 005

COMPANY PROFILE



TUV NORD (Thailand) Ltd.



NSC-TISI-TIS 17021-1
QMS 005

COMPANY

ATIPAT-THONNAWAT COMPANY LIMITED

ADDRESS

85/ 1,3,6,14 SUK SAWAT 78 RD., BANGCHAK, PHRA PRADAENG, SAMUT PRAKAN
POST CODE 10130

TEL

+662-464-1660-2, +662-464-1628-9

FAX

+662-464-1663

EMAIL

THONNAWAT.ATC@GMAIL.COM

WEBSITE

WWW.ATIPAT-THONNAWAT.COM

ESTABLISH

1987

CERTIFICATION

ISO 9001-2015

SCOPE OF BUSINESS

MANUFACTURING AND TRADING

- ELECTRICAL CONDUIT AND FITTINGS FOR EMT / IMC / RSC
- CONDUIT BODY AND BOXES
- ELECTRO GALVANISED AND HOT DIP GALVANISED
- C-CHANNEL AND ACCESSORIES
- CLAMP , HANGER AND SUPPORTS
- ELECTRICAL CABINETS
- WIREWAY AND ACCESSORIES

BRAND

ATC



OUR PROFILE

บริษัท อธิพัฒน์-ธนวัต จำกัด หรือ "ATC" จัดตั้งขึ้นเมื่อปี 2530 เพื่อดำเนินธุรกิจผลิตชิ้นส่วน Electrical and Conduit Fitting ด้วยประสบการณ์ และความเชี่ยวชาญในการผลิตนานกว่า 30 ปี สินค้าของบริษัทฯได้ถูกนำไปใช้ในโครงการต่างๆ ทั้งจากหน่วยงานภาครัฐ และภาคเอกชน ได้แก่ งานก่อสร้างที่อยู่อาศัย อาคาร โรงงาน, ระบบส่งไฟฟ้า, งานก่อสร้างระบบขนส่ง และงานก่อสร้างท่าอากาศยาน เป็นต้น

ตั้งแต่เริ่มดำเนินธุรกิจ บริษัทฯก็มุ่งเน้นที่จะปรับปรุงและพัฒนาระบบการผลิตด้วยเครื่องจักรที่ทันสมัยเพื่อให้มั่นใจได้ว่า บริษัทฯจะส่งมอบสินค้าที่มีคุณภาพเป็นไปตามมาตรฐานระดับสากลให้กับลูกค้าได้อย่างตรงเวลารวมถึงมุ่งเน้นการพัฒนาความเป็นอยู่ ของชุมชนรอบๆโรงงานอย่างยั่งยืนบริษัทฯเป็นเจ้าของตราสินค้า " ATC " สำหรับงาน Hot Dip Galvanized และ " Q " สำหรับโครงการที่ต้องการสินค้าที่มีคุณภาพ

“บริษัท อธิพัฒน์-ธนวัต จำกัด มุ่งมั่นที่จะเป็นผู้นำในการผลิต และพัฒนานวัตกรรมใหม่ๆ เพื่อตอบสนองความต้องการของลูกค้า ด้วยสินค้าที่มีคุณภาพ และได้รับการยอมรับตามมาตรฐานสากล ตลอดจนการใส่ใจในสิ่งแวดล้อม เสริมสร้าง และอยู่ร่วมกับชุมชนได้อย่างยั่งยืน ”

OUR MISSION

- ให้ความสำคัญด้านคุณภาพในทุกขั้นตอนของกระบวนการผลิต จนถึงการส่งมอบเพื่อสร้างความพึงพอใจสูงสุดให้กับลูกค้า
- มุ่งเน้นการปรับปรุง และพัฒนาสินค้า และกระบวนการผลิต เพื่อให้บริษัทสามารถเติบโตได้อย่างยั่งยืน
- สร้างความไว้วางใจจากลูกค้า สามารถเป็นฐานการผลิตและส่งมอบสินค้าที่มีคุณภาพ และมาตรฐานให้กับลูกค้าทั้งในและต่างประเทศ และเจริญเติบโตอย่างมั่นคงพร้อมกับคู่ค้า
- จัดให้มีการกำกับดูแลที่ดี เพื่อสร้างการเติบโตที่ยั่งยืนและช่วยเหลือ ส่งเสริมชุมชนรอบข้างและสังคม
- สร้างเสริมบรรยากาศการทำงานที่ดี มีการพัฒนาศักยภาพบุคลากรอย่างเป็นระบบและต่อเนื่อง เกิดความสมดุลระหว่างชีวิตการทำงานและชีวิตส่วนตัวของพนักงาน



Atipat-Thonnawat Co., Ltd. or "ATC" was established in 1987 to operate the metal forming business for Electrical and Conduit Fitting Products. As an our experience for 30 years, our products have been used in various projects both public and private sectors (e.g. Residential and Building construction, Power Transmission System, Transportation and Airport)

Since our establishment, ATC has been focusing on development and improvement of the production process to ensure that we will be able to deliver High Quality Products with international standards to our customers. We own the "ATC" brand name for Hot Dip Galvanized Product and "Q" for the Project that required the quality conduit fitting.

“ To be a Top Manufacturer for the Customer with a High Class Quality of Conduit Fitting in the Region, with a full of Commitment to be a Corporate Governance. ”

- High Class Quality for Customer
- Development and Improvement for Sustainable Growth
- Sustainable Growth with Business Partnership
- Corporate Governance with Socialization
- Better Environment with Happiness Employee



PROJECT REFERENCES

EGCO's SPP Power Plant

WHA Warehouse

Bangkok Hospital, HUA-HIN



Suvarnabhumi Airport



The Energy Hua Hin



QUALITY CONDUIT FITTING

“Increasing your speed”

FAST INSTALLATION | FLEXIBILITY | QUALITY | COST EFFICIENCY

BTS RAILWAY



Queen Sirikit

Centralfestival



King Power, Phuket



Ideo



บริษัท อธิวัฒน์-ธนวิศ จำกัด

0-2464-1660-2



85/1,3,6,14 ซอยสุขสวัสดิ์ 78 หมู่ 7 ถนนสุขสวัสดิ์ ตำบลบางจาก อำเภอพระประแดง สมุทรปราการ 10130

85/1,3,6,14 Suk Sawat 78 Rd., Bang Chak, Phra Pradaeng, Samut Prakan, Thailand, 10130



info@atcelectrics.com



Website : <https://www.atcelectrics.com>

MEGA

PROJECT of ATIPAT-THONNAWAT



2016



LAEMCHABANG PORT
TYPE: PORT
LOCATION: CHONBURI



SUVANBHUMI AIRPORT- PHASE 2 CCL1
TYPE: AOT
LOCATION: BKK



MRT GREENLINE NORTH
TYPE: MRT
LOCATION: BKK

2017



รถไฟฟ้าสายสีแดง - GRAND STATION สัญญา1
TYPE: SRT
LOCATION: BKK



BTS- ช่อมบำรุงโรงจอด
TYPE: BTS
LOCATION: BKK

รถไฟฟ้ารางคู่จิระ-ขอนแก่น
TYPE: SRT
LOCATION: ขอนแก่น

MRT GREENLINE- PARK AND RIDE, and DEPOT
TYPE: MRT
LOCATION: BKK



SUVANBHUMI AIRPORT- PHASE 2 CCL2
TYPE: AOT
LOCATION: BKK



รถไฟฟ้าสายสีแดง - GRAND STATION สัญญา3
TYPE: SRT
LOCATION: BKK



MRT ORANGE LINE - E1
TYPE: MRT
LOCATION: BKK

2019



MRT ORANGE LINE - E5, DEPOT
TYPE: MRT
LOCATION: BKK



MRT ORANGE LINE - E4
TYPE: MRT
LOCATION: BKK



POWER PLANT 2500 Mwatt - Gulf Sriracha
TYPE: GULF/EGAT
LOCATION: CHONBUR



BMA GOLD LINE
TYPE: MASS TRANSIT
LOCATION: BKK



MEA - Outgoing Cable Tunnel of Chidlom Terminal
TYPE: MEA
LOCATION: BKK



รถไฟฟ้ารางคู่ มาบกะเบา - จิระ
TYPE: SRT
LOCATION: NORTHEAST OF THAILAND

รถไฟฟ้ารางคู่ หัวหิน - ประจวบคีรีขันธ์

TYPE: SRT
LOCATION: SOUTH OF THAILAND

2020 & MORE

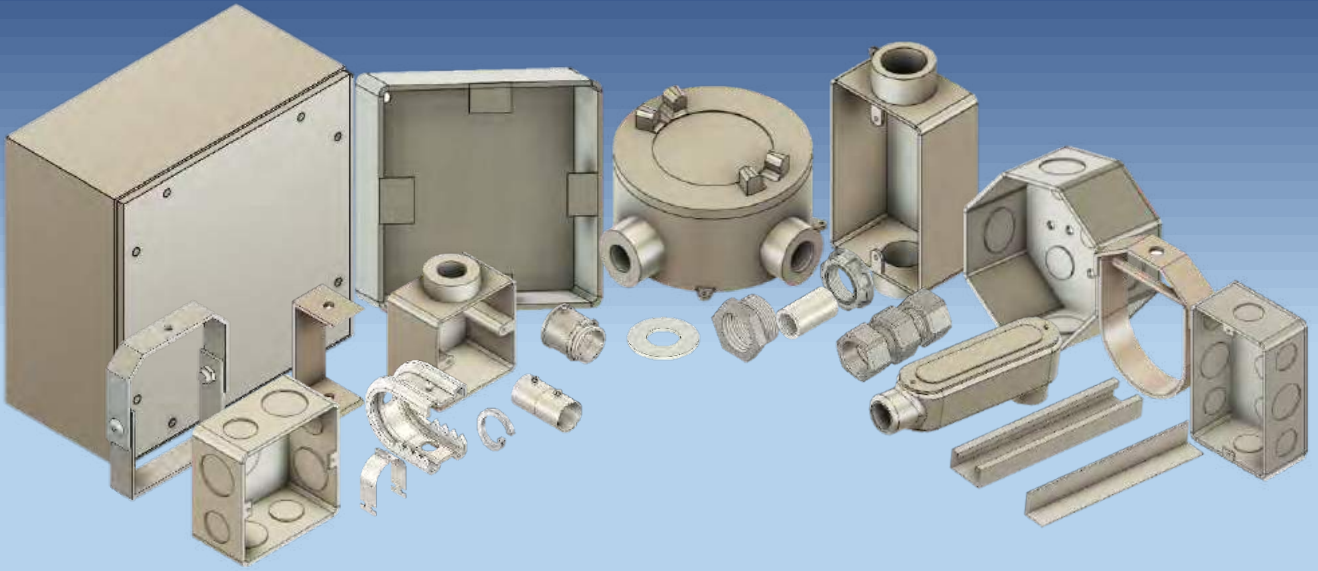

“มุ่งมั่นผลิตสินค้าที่มีคุณภาพ
ส่งตรงเวลา พัฒนات่อเนื่อง
พนักงานปลอดภัย
ลูกค้าพอใจสูงสุด”



การไฟฟ้านครหลวง Metropolitan Electricity Authority
สถาบันไฟฟ้าและอิเล็กทรอนิกส์ ELECTRICAL AND ELECTRONICS INSTITUTE

TUV NORD (Thailand) Ltd.

NSC-TISI-TIS 17021-1
QMS 005

CONTENTS

CONDUITS & FITTINGS

| PAGE 1



EMT CONDUIT
ท่อเหล็กธรมบาง



IMC CONDUIT
ท่อเหล็กธรมหนา



EMT CONDUIT ELBOW
ท่อค้งธรมบาง



IMC CONDUIT ELBOW
ท่อค้งธรมหนา

| PAGE 2



EMT,IMC STRAP
แคล้มจับท่อขาเดี่ยว



EMT,IMC STRAP 2SR
แคล้มจับท่อขาคู่



BACK PLATE FOR STRAP
ฐานรับแคล้มขาตู้



RSC CONDUIT
ท่อเหล็กธรมหนาพิเศษ

| PAGE 3



EMT CONNECTOR
คอนเนคเตอร์ท่อบาง



EMT COUPLING
ข้อต่อบาง



FLEXIBLE CONNECTOR
คอนเนคเตอร์ท่ออ่อน

| PAGE 4



IMC COUPLING
ข้อต่อหนา



REDUCING FLEXIBLE CONNECTOR
คอนเนคเตอร์ท่ออ่อนธรมพิเศษ



NM CONNECTOR
เอ็น.เอ็ม.คอนเนคเตอร์



ERICKSON COUPLING
อิริคสันคัปปีง

CONDUITS & FITTINGS

PAGE 5



BUSHING
บุชซิ่ง



LOCK NUT
ล็อกนัท



THREAD DECREASER
เกลียวลด



NIPPLE
ท่อหน้าช่วงสั้น



REDUCING WASHER
แหวนลด

PAGE 6



EMT CONNECTOR R/T
คอนเน็คเตอร์ท่อบางกั้นน้ำ



EMT COUPLING R/T
ข้อต่อบางกั้นน้ำ



FLEXIBLE CONNECTOR R/T
คอนเน็คเตอร์ท่ออ่อนกั้นน้ำ



FLEXIBLE CONNECTOR R/T 45
คอนเน็คเตอร์ท่ออ่อนกั้นน้ำ 45



FLEXIBLE CONNECTOR R/T 90
คอนเน็คเตอร์ท่ออ่อนกั้นน้ำ 90

PAGE 7



FLEXIBLE CONDUIT
ท่ออ่อนเหล็ก



FLEXIBLE CONDUIT R/T
ท่ออ่อนกั้นน้ำ



FLEXIBLE CONDUIT
ท่ออ่อนกั้นน้ำสีดำ



BLACK FLEXIBLE
CONDUIT CONNECTOR
คอนเน็คเตอร์ท่ออ่อนกั้นน้ำสีดำ



HUB CONNECTOR R/T
ฮับคอนเน็คเตอร์กั้นน้ำ



FLEXIBLE CONDUIT INTERLOCK
ท่อเหล็กอ่อนอินเตอร์ล๊อค



FLEXIBLE CONDUIT LOWSMOKE
ZERO HALOGEN
ท่อเหล็กอ่อนโลวสโมค



FLEXIBLE CONDUIT LOW SMOKE
CONNECTOR R/T
คอนเน็คเตอร์ท่อโลวสโมค
ชนิดกั้นน้ำ

CONDUIT BODY & JUNCTION BOXES

PAGE 8



HANDY BOX 2" X 4"
แชนดี่บ็อกซ์ 2" X 4"

PAGE 9



SQUARE BOX 4" X 4"
สแควร์บ็อกซ์ 4" X 4"

PAGE 10



COVER FOR HANDY BOX 2" X 4"
ฝาปิดแชนดี่บ็อกซ์ 2" X 4"



COVER FOR HANDY BOX 4" X 4"
ฝาปิดแชนดี่บ็อกซ์ 4" X 4"

PAGE 11



MK BOX
เอ็ม.เค. บ็อกซ์



EUROPA BOX 3" X 5"
ยุโรป้าบ็อกซ์

PAGE 12



OCTAGON BOX
อ็อกตาท่อนบ็อกซ์



COVER FOR OCTAGON BOX
ฝาปิดอ็อกตาท่อนบ็อกซ์

CONDUIT BODY & JUNCTION BOXES

PAGE 13



FS BOX 2" X 4"
แอฟ.เอส. บ็อกซ์ 2" X 4"



COVER PLATE FOR F.S. BOX 2" X 4"
ฝาปิด แอฟ.เอส. บ็อกซ์ 2" X 4"

PAGE 14



FS BOX 4" X 4"
แอฟ.เอส. บ็อกซ์ 4" X 4"



COVER PLATE FOR F.S. BOX 4" X 4"
ฝาปิด แอฟ.เอส. บ็อกซ์ 4" X 4"

PAGE 15



CONDUIT BODY L.B.
คอนดุกทอด้ L.B.



CONDUIT BODY L.L.
คอนดุกทอด้ L.L.

PAGE 16



CONDUIT BODY L.R.
คอนดุกทอด้ L.R.



CONDUIT BODY O.T.
คอนดุกทอด้ O.T.

PAGE 17



CONDUIT BODY O.C.
คอนดุกทอด้ O.C.



CONDUIT BODY T.B.
คอนดุกทอด้ T.B.



SERVICE ENTRANCE CAP
หัวงูเห่า

CONDUIT BODY & JUNCTION BOXES

PAGE 18



CIRCULAR BOX 1 WAY
บ็อกกลมก้นน้ำ 1 ทาง



ANGLE CIRCULAR BOX
บ็อกกลมก้นน้ำ 2 ทาง ฉาก



THROUGH CIRCULAR BOX
บ็อกกลมก้นน้ำ 2 ทาง ตรงข้าม

PAGE 18



THREE WAY CIRCULAR BOX
บ็อกกลมก้นน้ำ 3 ทาง



INTERSECT CIRCULAR BOX
บ็อกกลมก้นน้ำ 4 ทาง

PAGE 19



FS BOX 3" X 5"
เอฟ.เอส. บ็อกซ์ 3" X 5"



OUTLET BOX
บ็อกซ์หุ้ย้น



BALL FLANGE
ฝาเป็นลูกหมาก

C - CHANNEL & ACCESSORIES

PAGE 20



C-CHANNEL
รางตัวซี

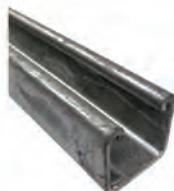

ซุ่มรุ่ง



ซุ่มขาว

IMC, EMT CONDUIT CLIPS
แคลมป์ประกบรางตัวซี

CLAMPS & HANGERS

PAGE 21



STANDARD CLAMPS
แคล้มวงเดือน



BEAM CLAMP
แคล้มพินจระเข้



PIPE HANGER
แคล้มแขวน

PAGE 22



CLEVIS HANGER
แคล้มยึด



U-BOLT
ยูโบลท์

LIGHTING PROTECTION & GROUNDING CONNECTION

PAGE 23



AIR TERMINAL BASE
ฐานล่อฟ้า



AIR TERMINAL ROD
เสาล่อฟ้า

PAGE 24



AIR TER
ล่อฟ้าสามแฉก



GROUND ROD
กรวดท่อทองแดง

PULL BOX, WIRE WAY & ACCESSORIES

PAGE 25



PULL BOX
พูน็อกซ์

PAGE 26



WIRE WAY
(LENGTH 2400 mm)



WIRE WAY HANGER SUPPORT
ตัวแขวนรางไวร์เวย์

PULL BOX, WIRE WAY & ACCESSORIES

| PAGE 27



90 degree WIREWAY ACCESSORIES
อุปกรณ์เสริมรางไวร์เวย์ 90 องศา

| PAGE 28



HORIZONTAL TEE
อุปกรณ์เสริมรางไวร์เวย์ 3 ทิศ

| PAGE 29

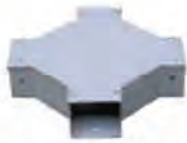

HORIZONTAL CROSS
อุปกรณ์เสริมรางไวร์เวย์ 4 ทิศ



CABLE LADDER

HOT DIP GALVANISED CONDUIT FITTING & ACCESSORIES

| PAGE 30



STUD THREAD ROD
HOT DIP GALVANISED



HEXAGONAL COUPLING
HOT DIP GALVANISED



ROUND WASHER
HOT DIP GALVANISED



ROUND SPRING WASHER
HOT DIP GALVANISED



SCREWS AND NUT
HOT DIP GALVANISED



BAND HANGER



STRAP U BOLT



UB CLAMP



SPRING NUT

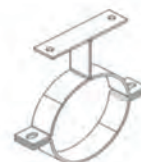

HOPE PIPE CLAMP SET TYPE-B



EQUAL ANGLE STEEL

HOT DIP GALVANISED CONDUIT FITTING & ACCESSORIES

PAGE 31

 <p>SQUARE WASHER HOT DIP GALVANISED</p>	 <p>SCREW AND NUTS HOT DIP GALVANISED</p>	 <p>CONDUIT STRAPS HOT DIP GALVANISED</p>	 <p>G-CHANNEL HOT DIP GALVANISED</p>
---	--	---	---

PAGE 31

 <p>CONDUITCLAMP FOR G-CHANNEL HOT DIP GALVANISED</p>	 <p>DOUBLE STRUT CHANNEL</p>	 <p>STRUT FITTING ACCESSORIES</p>
---	--	--

PAGE 32

 <p>SQUARE BOX HOT DIP GALVANISED</p>	 <p>HANDY BOX HOT DIP GALVANISED</p>	 <p>COVER FOR SQUARE BOX (NORMAL) COVER FOR SQUARE BOX DEEP HOT DIP GALVANISED</p>	 <p>COVER FOR HANDY BOX HOT DIP GALVANISED</p>
--	---	--	---

PAGE 33

 <p>EUROPA BOX HOT DIP GALVANISED</p>	 <p>OCTAGON BOX HOT DIP GALVANISED</p>	 <p>JUMBO SQUARE BOX 5"x5" HOT DIP GALVANISED</p>
--	---	---

HOT DIP GALVANISED CONDUIT FITTING & ACCESSORIES

PAGE 33



COVER FOR EUROPA BOX
HOT DIP GALVANISED



COVER FOR OCTAGON BOX
HOT DIP GALVANISED



COVER FOR JUMBO BOX 5"x5"
HOT DIP GALVANISED

PAGE 34



MK BOX
HOT DIP GALVANISED



APPLICABLE HANGERS
HOT DIP GALVANISED



BEAM CLAMPS
HOT DIP GALVANISED



IMC/RSC COUPLING
HOT DIP GALVANISED

PAGE 35



PULL BOX
HOT DIP GALVANISED



MILD STEEL BUSHINGS
HOT DIP GALVANISED



MILD STEEL LOCKNUTS
HOT DIP GALVANISED

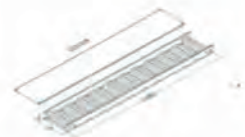

CABLE TRAY

PAGE 36



EMT CONNECTOR
HOT DIP GALVANISED



EMT COUPLING
HOT DIP GALVANISED



CHASE NIPPLE
HOT DIP GALVANISED



90 HORIZONTAL BEND



CONDUITS & FITTINGS

EMT CONDUIT

IMC CONDUIT

ท่อเหล็ก รุ่มบาง

ท่อเหล็ก รุ่มหนา

CODE	SIZE	PRICE
ECD01	1/2"	133.00
ECD02	3/4"	192.00
ECD03	1"	273.00
ECD04	1 1/4"	476.00
ECD05	1 1/2"	555.00
ECD06	2"	688.00

CODE	SIZE	PRICE
ICD01	1/2"	282.00
ICD02	3/4"	375.00
ICD03	1"	506.00
ICD04	1 1/4"	653.00
ICD05	1 1/2"	802.00
ICD06	2"	1,096.00



EMT CONDUIT

IMC CONDUIT

ท่อเหล็ก รุ่มบาง

ท่อเหล็ก รุ่มหนา

CODE	SIZE	PRICE
ECD01	1/2"	133.00
ECD02	3/4"	192.00
ECD03	1"	273.00
ECD04	1 1/4"	476.00
ECD05	1 1/2"	555.00
ECD06	2"	688.00

CODE	SIZE	PRICE
ICD01	1/2"	282.00
ICD02	3/4"	375.00
ICD03	1"	506.00
ICD04	1 1/4"	653.00
ICD05	1 1/2"	802.00
ICD06	2"	1,096.00



EMT ELBOW 45

IMC ELBOW 45

ท่อโค้ง รุ่มบาง 45

ท่อโค้ง รุ่มหนา 45

CODE	SIZE	PRICE
EEB01	1/2"	20.00
EEB02	3/4"	28.00
EEB03	1"	41.00
EEB04	1 1/4"	80.00
EEB05	1 1/2"	102.00
EEB06	2"	134.00

CODE	SIZE	PRICE
IEB01	1/2"	52.00
IEB02	3/4"	61.00
IEB03	1"	95.00
IEB04	1 1/4"	123.00
IEB05	1 1/2"	180.00
IEB06	2"	247.00



EMT ELBOW 90

IMC ELBOW 90

ท่อโค้ง รุ่มบาง 90

ท่อโค้ง รุ่มหนา 90

CODE	SIZE	PRICE
EEL01	1/2"	31.50
EEL02	3/4"	42.00
EEL03	1"	62.75
EEL04	1 1/4"	95.00
EEL05	1 1/2"	123.50
EEL06	2"	161.50
EEL07	2 1/2"	-
EEL08	3"	-
EEL09	3 1/2"	-
EEL10	4"	-

CODE	SIZE	PRICE
IEL01	1/2"	52.25
IEL02	3/4"	61.75
IEL03	1"	95.00
IEL04	1 1/4"	123.50
IEL05	1 1/2"	180.50
IEL06	2"	247.00
IEL07	2 1/2"	666.00
IEL08	3"	954.00
IEL09	3 1/2"	1,800.00
IEL10	4"	2,160.00





RSC CONDUIT

ท่อเหล็กชุบหนาพิเศษ

CODE	SIZE	PRICE
RCD01	1/2"	342.00
RCD02	3/4"	436.00
RCD03	1"	641.00
RCD04	1 1/4"	828.00
RCD05	1 1/2"	985.00
RCD06	2"	1,317.00
RCD07	2 1/2"	1,979.00
RCD08	3"	2,543.00
RCD09	3 1/2"	3,335.00
RCD10	4"	3,747.00
RCD11	5"	5,389.00
RCD12	6"	6,449.00



RSC ELBOW 90

ท่อโค้ง 90 ชุบหนาพิเศษ

CODE	SIZE	PRICE
HELBR01	1/2"	130.00
HELBR02	3/4"	150.00
HELBR03	1"	240.00
HELBR04	1 1/4"	400.00
HELBR05	1 1/2"	450.00
HELBR06	2"	730.00
HELBR07	2 1/2"	1590.00
HELBR08	3"	2450.00
HELBR09	3 1/2"	4050.00
HELBR10	4"	4900.00
HELBR11	5"	13800.00
HELBR12	6"	17900.00

FLEXIBLE CONDUIT INTERLOCK

ท่อโลหะอ่อน อินเตอร์ล็อก

CODE	SIZE	PRICE
FCI01	1/2"	18.00
FCI02	3/4"	24.00
FCI03	1"	36.00
FCI04	1 1/4"	66.00
FCI05	1 1/2"	90.00
FCI06	2"	110.00
FCI07	2 1/2"	200.00
FCI08	3"	240.00
FCI09	4"	450.00



FLEXIBLE CONDUIT LOW SMOKE ZERO HALOGEN

ท่อโลหะอ่อน โลวสโมค

CODE	SIZE	LENGTH	PRICE
FCLS01	1/2"	30 M	5,625.00
FCLS02	3/4"	30 M	6,772.00
FCLS03	1"	30 M	10,338.75
FCLS04	1 1/4"	15 M	4,950.00
FCLS05	1 1/2"	15 M	8,550.00
FCLS06	2"	15 M	11,756.25
FCLS07	2 1/2"	-	-
FCLS08	3"	-	-
FCLS09	4"	-	-





EMT STRAP 1 SR

แฉล้บจับท่อดชาเดี่ยว (E.M.T)

CODE	SIZE	PRICE
EC1L01	1/2"	1.25
EC1L02	3/4"	1.3
EC1L03	1"	2
EC1L04	1 1/4"	-
EC1L05	1 1/2"	-
EC1L06	2"	-

IMC STRAP 1 SR

แฉล้บจับท่อดชาเดี่ยว (I.M.C.)

CODE	SIZE	PRICE
IC1L01	1/2"	1.25
IC1L02	3/4"	1.3
IC1L03	1"	2
IC1L04	1 1/4"	-
IC1L05	1 1/2"	-
IC1L06	2"	-



EMT STRAP 2 SR

แฉล้บจับท่อดชาคู่ (E.M.T)

CODE	SIZE	PRICE
EC2L01	1/2"	1.60
EC2L02	3/4"	2.00
EC2L03	1"	3.20
EC2L04	1 1/4"	6.00
EC2L05	1 1/2"	8.00
EC2L06	2"	10.00

IMC STRAP 2 SR

แฉล้บจับท่อดชาคู่ (I.M.C.)

CODE	SIZE	PRICE
IC2L01	1/2"	1.60
IC2L02	3/4"	2.00
IC2L03	1"	3.20
IC2L04	1 1/4"	6.00
IC2L05	1 1/2"	8.00
IC2L06	2"	10.00
IC2L07	2 1/2"	17.00
IC2L08	3"	20.00
IC2L09	3 1/2"	26.00
IC2L10	4"	28.00

BACK PLATE FOR STRAP

ฐานรับแฉล้บชาคู่

CODE	SIZE	PRICE
BPS01	1/2"	12.00
BPS02	3/4"	14.00
BPS03	1"	16.00
BPS04	1 1/4"	22.00
BPS05	1 1/2"	28.00
BPS06	2"	38.00



CONDUITS & FITTINGS



EMT CONNECTOR

คอนเน็คเตอร์ท่อบาง

CODE	SIZE	PRICE
ECN01	1/2"	5.00
ECN02	3/4"	9.00
ECN03	1"	12.25
ECN04	1 1/4"	19.00
ECN05	1 1/2"	27.25
ECN06	2"	43.50

EMT COUPLING

ข้อต่อท่อบาง

CODE	SIZE	PRICE
ECP01	1/2"	6.00
ECP02	3/4"	10.00
ECP03	1"	13.50
ECP04	1 1/4"	23.00
ECP05	1 1/2"	31.00
ECP06	2"	47.50

FLEXIBLE CONDUIT CONNECTOR

คอนเน็คเตอร์ท่ออ่อน

CODE	SIZE	PRICE
FCN01	1/2"	7.00
FCN02	3/4"	14.50
FCN03	1"	21.50
FCN04	1 1/4"	73.00
FCN05	1 1/2"	95.00
FCN06	2"	120.00
FCN07	2 1/2"	189.00
FCN08	3"	254.00
FCN09	4"	468.00



BUSHING

บุชซิ่ง

CODE	SIZE	PRICE
BS01	1/2"	3.25
BS02	3/4"	4.25
BS03	1"	7.75
BS04	1 1/4"	12.25
BS05	1 1/2"	15.00
BS06	2"	21.75
BS07	2 1/2"	39.25
BS08	3"	45.00
BS09	3 1/2"	112.00
BS10	4"	122.00
BS11	5"	480.00
BS12	6"	660.00

LOCKNUT

ล็อคนัท

CODE	SIZE	PRICE
LN01	1/2"	2.75
LN02	3/4"	3.50
LN03	1"	4.75
LN04	1 1/4"	8.75
LN05	1 1/2"	11.00
LN06	2"	14.00
LN07	2 1/2"	26.50
LN08	3"	38.50
LN09	3 1/2"	53.50
LN10	4"	69.50
LN11	5"	470.00
LN12	6"	640.00

IMC COUPLING

ข้อต่อหนา

CODE	SIZE	PRICE
ICP01	1/2"	18.00
ICP02	3/4"	21.50
ICP03	1"	27.50
ICP04	1 1/4"	42.00
ICP05	1 1/2"	51.50
ICP06	2"	88.50
ICP07	2 1/2"	182.00
ICP08	3"	253.00
ICP09	3 1/2"	351.00
ICP10	4"	382.00
ICP11	5"	860.00
ICP12	6"	-



REDUCING FLEXIBLE CONDUIT CONNECTOR

คอนเน็คเตอร์ท่ออ่อนรุ่นพิเศษ

CODE	SIZE	PRICE
FCN01S	3/4"-1/2"	15.50
FCN02S	1"-3/4"	23.50



NIPPLE

ท่อหน้าขวงสั้น

CODE	SIZE	PRICE
NP01	1/2"	27.00
NP02	3/4"	34.50
NP03	1"	45.00
NP04	1 1/4"	60.00
NP05	1 1/2"	78.00
NP06	2"	120.00
NP07	2 1/2"	210.00
NP08	3"	270.00
NP09	3 1/2"	360.00
NP10	4"	450.00



REDUCING BUSHING

เกลียวขาด

CODE	SIZE	PRICE
RB01	3/4" TO 1/2"	14.50
RB02	1" TO 1/2"	19.00
RB03	1" TO 3/4"	19.00
RB04	1 1/4" TO 1/2"	46.50
RB05	1 1/4" TO 3/4"	46.50
RB06	1 1/4" TO 1"	46.50
RB07	1 1/2" TO 1/2"	54.50
RB08	1 1/2" TO 3/4"	54.50
RB09	1 1/2" TO 1"	46.50
RB10	1 1/2" TO 1 1/4"	46.50



ERICKSON COUPLING

อีริคสัน คัปปีง

CODE	SIZE	PRICE
ERCP01	1/2"	60.00
ERCP02	3/4"	75.00
ERCP03	1"	98.00
ERCP04	1 1/4"	172.00
ERCP05	1 1/2"	225.00
ERCP06	2"	307.00



NM CONNECTOR

เอ็นเอ็มคอนเน็คเตอร์

CODE	SIZE	PRICE
NMC01	1/2"	9.00
NMC02	3/4"	27.00
NMC03	1"	90.00



REDUCING WASHER

แหวนลด

CODE	SIZE	PRICE
RW01	3/4" TO 1/2"	1.00
RW02	1" TO 1/2"	2.00
RW03	1" TO 3/4"	2.00

CODE	SIZE	PRICE
RB11	2" TO 1/2"	112.00
RB12	2" TO 3/4"	112.00
RB13	2" TO 1"	112.00
RB14	2" TO 1 1/4"	91.00
RB15	2" TO 1 1/2"	72.00
RB16	2 1/2" TO 2"	136.00
RB17	3" TO 2"	256.00
RB18	3" TO 2 1/2"	224.00
RB19	4" TO 3"	352.00
RB20	4" TO 3 1/2"	272.00



EMT CONNECTOR RAIN TIGHT

คอนเน็คเตอร์ท่อบางกันน้ำ

EMT COUPLING RAIN TIGHT

ข้อต่อบางกันน้ำ

CODE	SIZE	PRICE
EC01RT	½ "	13.25
EC02RT	¾ "	18.25
EC03RT	1"	29.75
EC04RT	1 ¼ "	51.75
EC05RT	1 ½ "	82.50
EC06RT	2 "	119.00

CODE	SIZE	PRICE
ECP01RT	½ "	15.00
ECP02RT	¾ "	20.00
ECP03RT	1"	34.00
ECP04RT	1 ¼ "	61.00
ECP05RT	1 ½ "	97.00
ECP06RT	2 "	127.00

FLEXIBLE CONNECTOR RAIN TIGHT

คอนเน็คเตอร์ท่ออ่อนกันน้ำ

STRAIGHT



ANGLE45



BEND 90



CODE	SIZE	PRICE
FCN01RT	½ "	29.50
FCN02RT	¾ "	39.25
FCN03RT	1"	73.50
FCN04RT	1 ¼ "	122.50
FCN05RT	1 ½ "	176.50
FCN06RT	2 "	304.00
FCN07RT	2 ½ "	588.00
FCN08RT	3 "	735.00
FCN09RT	4 "	980.00

CODE	SIZE	PRICE
FCN01RT1	½ "	162.00
FCN02RT1	¾ "	270.00
FCN03RT1	1"	470.00
FCN04RT1	1 ¼ "	800.00
FCN05RT1	1 ½ "	930.00
FCN06RT1	2 "	1,060.00
FCN07RT1	2 ½ "	1,860.00
FCN08RT1	3 "	2,750.00
FCN09RT1	4 "	4,050.00

CODE	SIZE	PRICE
FCN01RT2	½ "	162.00
FCN02RT2	¾ "	270.00
FCN03RT2	1"	470.00
FCN04RT2	1 ¼ "	800.00
FCN05RT2	1 ½ "	930.00
FCN06RT2	2 "	1,060.00
FCN07RT2	2 ½ "	1,860.00
FCN08RT2	3 "	2,750.00
FCN09RT2	4 "	4,050.00



FLEXIBLE CONDUIT
ท่ออ่อนเหล็ก

CODE	SIZE	PRICE
FC01	1/2"	18.00
FC02	3/4"	24.00
FC03	1"	36.00
FC04	1 1/4"	66.00
FC05	1 1/2"	90.00
FC06	2"	110.00
FC07	2 1/2"	200.00
FC08	3"	240.00
FC09	4"	450.00



FLEXIBLE CONDUIT RAIN TIGHT
ท่ออ่อนกันน้ำ

CODE	SIZE	PRICE
FC01RT	1/2"	31.00
FC02RT	3/4"	41.00
FC03RT	1"	68.00
FC04RT	1 1/4"	82.00
FC05RT	1 1/2"	110.00
FC06RT	2"	138.00
FC07RT	2 1/2"	276.00
FC08RT	3"	414.00
FC09RT	4"	550.00



BLACK FLEXIBLE CONDUIT
ท่ออ่อนกันน้ำสีดำ

CODE	SIZE	PRICE
FC01RTB	3/8"	30.00
FC02RTB	1/2"	45.00
FC03RTB	3/4"	65.00
FC04RTB	1"	90.00
FC05RTB	1 1/4"	140.00
FC06RTB	1 1/2"	170.00
FC07RTB	2"	230.00
FC08RTB	2 1/2"	350.00
FC09RTB	3"	400.00
FC10RTB	4"	600.00



BLACK FLEXIBLE CONDUIT CONNECTOR
คอนเน็คเตอร์ท่ออ่อนกันน้ำสีดำ

CODE	SIZE	PRICE
FCN01RTB	3/8"	35.00
FCN02RTB	1/2"	50.00
FCN03RTB	3/4"	70.00
FCN04RTB	1"	120.00
FCN05RTB	1 1/4"	180.00
FCN06RTB	1 1/2"	240.00
FCN07RTB	2"	340.00
FCN08RTB	2 1/2"	440.00
FCN09RTB	3"	600.00
FCN10RTB	4"	1,000.00



HUB CONNECTOR R/T
ฮับคอนเน็คเตอร์กันน้ำ

CODE	SIZE	PRICE
HC01	1/2"	110.00
HC02	3/4"	125.00
HC03	1"	150.00
HC04	1 1/4"	250.00
HC05	1 1/2"	340.00
HC06	2"	460.00

EARTH TAG



CODE	ENTRY THREAD SIZE
ET20	1/2"
ET25	3/4"
ET32	1"
ET40	1-1/4"
ET50	1-1/2"
ET63	2"
ET75	2-1/2"
ET90	3"
ET100	3-1/2"
ET115	4"

HANDY BOX

ແອນດີບັອກ 2" X 4"



T = 0.8 mm. (ຊັບສຸມຕາ)

CODE	REF. NAME	SIDES KNOCKOUTS	ENDS KNOCKOUTS	BOTTOM KNOCKOUTS	Dimension (mm)			PRICE (BAHT)
					A	B	C	
HB0107	ດັບ	1/2" x 3/4" x 1/2"	1/2"	3 x 1/2"	99.0	63.9	36.5	8.00
HB0207	ດັບທົບ	NO	1/2"	3 x 1/2"	99.0	63.9	36.5	10.00
HB0107ER	ດັບທັນະຊຸ	1/2" x 3/4" x 1/2"	1/2"	EXTENSION	99.0	63.9	36.5	9.00
HBD0107	ລັກ	1/2" x 3/4" x 1/2"	1/2" AND 3/4"	3 x 1/2"	99.0	63.9	45.0	12.00
HBD0207	ລັກ 3"/4" ລ້ວນ	3/4"	3/4"	3 x 1/2"	99.0	63.9	45.0	12.00
HBD0307	ລັກທົບ	NO	1/2" AND 3/4"	3 x 1/2"	99.0	63.9	45.0	14.00
HBD0107ER	ລັກທັນະຊຸ	1/2" x 3/4" x 1/2"	1/2" AND 3/4"	EXTENSION	99.0	63.9	45.0	13.00

T = 1.0 mm. (ຊັບສຸມ 1.0 ມມ.)

CODE	REF. NAME	SIDES KNOCKOUTS	ENDS KNOCKOUTS	BOTTOM KNOCKOUTS	Dimension (mm)			PRICE (BAHT)
					A	B	C	
HB0107	ດັບ	1/2" x 3/4" x 1/2"	1/2"	3 x 1/2"	99.0	63.9	36.5	22.00
HB0207	ດັບທົບ	NO	1/2"	3 x 1/2"	99.0	63.9	36.5	22.00
HB0107ER	ດັບທັນະຊຸ	1/2" x 3/4" x 1/2"	1/2"	EXTENSION	99.0	63.9	36.5	24.00
HBD0107	ລັກ	1/2" x 3/4" x 1/2"	1/2" AND 3/4"	3 x 1/2"	99.0	63.9	45.0	33.00
HBD0207	ລັກ 3"/4" ລ້ວນ	3/4"	3/4"	3 x 1/2"	99.0	63.9	45.0	33.00
HBD0307	ລັກທົບ	NO	1/2" AND 3/4"	3 x 1/2"	99.0	63.9	45.0	33.00
HBD0107ER	ລັກທັນະຊຸ	1/2" x 3/4" x 1/2"	1/2" AND 3/4"	EXTENSION	99.0	63.9	45.0	35.00

T = 1.2 mm. (ຊັບສຸມ 1.2 ມມ.)

CODE	REF. NAME	SIDES KNOCKOUTS	ENDS KNOCKOUTS	BOTTOM KNOCKOUTS	Dimension (mm)			PRICE (BAHT)
					A	B	C	
HB0107	ດັບ	1/2" x 3/4" x 1/2"	1/2"	3 x 1/2"	99.0	63.9	36.5	36.00
HB0207	ດັບທົບ	NO	1/2"	3 x 1/2"	99.0	63.9	36.5	45.00
HB0107ER	ດັບທັນະຊຸ	1/2" x 3/4" x 1/2"	1/2"	EXTENSION	99.0	63.9	36.5	40.00
HBD0107	ລັກ	1/2" x 3/4" x 1/2"	1/2" AND 3/4"	3 x 1/2"	99.0	63.9	45.0	44.00
HBD0207	ລັກ 3"/4" ລ້ວນ	3/4"	3/4"	3 x 1/2"	99.0	63.9	45.0	44.00
HBD0307	ລັກທົບ	NO	1/2" AND 3/4"	3 x 1/2"	99.0	63.9	45.0	52.00
HBD0107ER	ລັກທັນະຊຸ	1/2" x 3/4" x 1/2"	1/2" AND 3/4"	EXTENSION	99.0	63.9	45.0	48.00



SQUARE BOX 4" X 4"

ສາມແຈສ່ວນ 4" X 4"

T = 0.8 mm. (ຊຸມຮຽມ) (ຊຸມຮຽມ)

CODE	REF. NAME	SIDES KNOCKOUTS	BOTTOM KNOCKOUTS	Dimension (mm)			PRICE (BAHT)
				A	B	C	
SB01	ຕັ້ນ	1/2", 3/4", 1/2"	3 x 1/2", 2 x 3/4"	99.8	99.8	37.0	13.00
SB02	ຕັ້ນທົບ	NO	NO	99.8	99.8	37.0	15.00
SB01ER	ຕັ້ນທັນ-ຊຸ	1/2", 3/4", 1/2"	EXTENSION	99.8	99.8	37.0	14.00
SBD01	ລັກ	1/2", 3/4", 1/2"	3 x 1/2", 2 x 3/4"	99.8	99.8	48.5	17.00
SBD02	ລັກ 3"/4" ລ້ວນ	2 x 3/4"	3 x 1/2", 2 x 3/4"	99.8	99.8	48.5	17.00
SBD03	ລັກ 1" ລ້ວນ	2 x 1"	3 x 1/2", 2 x 3/4"	99.8	99.8	48.5	17.00
SBD04	ລັກທົບ	NO	NO	99.8	99.8	48.5	19.00
SBD01ER	ລັກທັນ-ຊຸ	1/2", 3/4", 1/2"	EXTENSION	99.8	99.8	48.5	18.00

T = 1.0 mm. (ຊຸມກາ 1.0 ມມ.)

CODE	REF. NAME	SIDES KNOCKOUTS	BOTTOM KNOCKOUTS	Dimension (mm)			PRICE (BAHT)
				A	B	C	
SB01	ຕັ້ນ	1/2", 3/4", 1/2"	3 x 1/2", 2 x 3/4"	99.8	99.8	37.0	33.00
SB02	ຕັ້ນທົບ	NO	NO	99.8	99.8	37.0	33.00
SB01ER	ຕັ້ນທັນ-ຊຸ	1/2", 3/4", 1/2"	EXTENSION	99.8	99.8	37.0	35.00
SBD01	ລັກ	1/2", 3/4", 1/2"	3 x 1/2", 2 x 3/4"	99.8	99.8	48.5	42.00
SBD02	ລັກ 3"/4" ລ້ວນ	2 x 3/4"	3 x 1/2", 2 x 3/4"	99.8	99.8	48.5	42.00
SBD03	ລັກ 1" ລ້ວນ	2 x 1"	3 x 1/2", 2 x 3/4"	99.8	99.8	48.5	42.00
SBD04	ລັກທົບ	NO	NO	99.8	99.8	48.5	42.00
SBD01ER	ລັກທັນ-ຊຸ	1/2", 3/4", 1/2"	EXTENSION	99.8	99.8	48.5	44.00

T = 1.2 mm. (ຊຸມກາ 1.2 ມມ.)

CODE	REF. NAME	SIDES KNOCKOUTS	BOTTOM KNOCKOUTS	Dimension (mm)			PRICE (BAHT)
				A	B	C	
SB01	ຕັ້ນ	1/2", 3/4", 1/2"	3 x 1/2", 2 x 3/4"	99.8	99.8	37.0	44.00
SB02	ຕັ້ນທົບ	NO	NO	99.8	99.8	37.0	52.00
SB01ER	ຕັ້ນທັນ-ຊຸ	1/2", 3/4", 1/2"	EXTENSION	99.8	99.8	37.0	48.00
SBD01	ລັກ	1/2", 3/4", 1/2"	3 x 1/2", 2 x 3/4"	99.8	99.8	48.5	54.00
SBD02	ລັກ 3"/4" ລ້ວນ	2 x 3/4"	3 x 1/2", 2 x 3/4"	99.8	99.8	48.5	54.00
SBD03	ລັກ 1" ລ້ວນ	2 x 1"	3 x 1/2", 2 x 3/4"	99.8	99.8	48.5	54.00
SBD04	ລັກທົບ	NO	NO	99.8	99.8	48.5	62.00
SBD01ER	ລັກທັນ-ຊຸ	1/2", 3/4", 1/2"	EXTENSION	99.8	99.8	48.5	58.00



CONDUITS BODIES & JUNCTION BOXES

COVER PLATE FOR HANDY BOX 2" X 4"

ฝาปิดแฮนด์บ็อกซ์ 2" X 4"



HBC01



HBC02



HBC03



HBC04



HBC05



HBC06

CODE	REF.NAME	PRODUCT	PRICE	
			รุ่นธรรมดา	รุ่นหนา
HBC01	ปิดมิด	BLANK COVER	3.20	8.50
HBC02	น๊อครู	BLANK 1/2" KNOCKOUT	3.40	8.50
HBC03	สวิตช์	TOGGLE SWITCH	4.00	-
HBC04	ปลั๊กคู่	DUPLEX RECEPTACLE	4.00	-
HBC05	ปลั๊กเล็ก	SINGLE RECEPTACLE 1.4"	4.00	-
HBC06	ปลั๊กกลาง	SINGLE RECEPTACLE 1.6"	4.00	-

COVER PLATE FOR SQUARE BOX 4" X 4"

ฝาปิดสแควร์บ็อกซ์ 4" X 4"



SBC01



SBC02



SBC03



SBC04



SBC05



SBC06



SBC07

CODE	REF.NAME	PRODUCT	PRICE	
			รุ่นธรรมดา	รุ่นหนา
SBC01	ปิดมิด	BLANK COVER	4.00	10.50
SBC02	น๊อครู	1/2" KNOCKOUT AT CENTER	5.00	10.50
SBC03	เสริมเรียบเดี่ยว	BLANK FOR ONE DEVICE	-	12.00
SBC04	เสริมเรียบคู่	BLANK FOR TWO DEVICES	-	12.00
SBC05	เสริมนูนเดี่ยว	COVER FOR ONE DEVICE 1/4" RAISED	-	14.50
SBC06	เสริมนูนคู่	COVER FOR TWO DEVICE 1/4" RAISED	-	14.50
SBC07	เสริมนูนกลม	COVER FOR CIRCULAR DVICE 1/4" RAISED	-	21.00

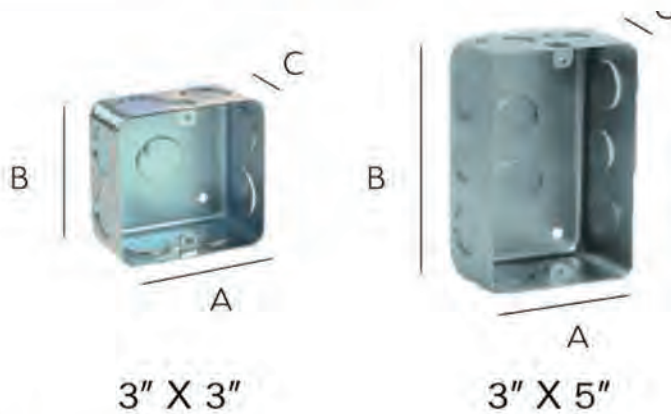

MK BOX
เอ็ม.เค บ็อกซ์

MK BOX 3" X 3"

CODE	şu	SIDE KNOCKOUTS	Dimension (mm)			PRICE (BAHT)
			A	B	C	
MKB0108	T = 0.8 mm	2 X 1/2"	72.5	72.5	36	15.00
MKB0110	T = 1.0 mm	2 X 1/2"	72.5	72.5	36	33.00
MKB0112	T = 1.2 mm	2 X 1/2"	72.5	72.5	36	45.00

MK BOX 3" X 5"

CODE	şu	SIDE KNOCKOUTS	Dimension (mm)			PRICE (BAHT)
			A	B	C	
MKB0210	T = 1.0 mm	3/4" X 1/2" X 3/4"	72.5	125	50	90.00
MKB0212	T = 1.2 mm	3/4" X 1/2" X 3/4"	72.5	125	50	120.00



EUROPA BOX 3" X 5"
ยุโรป้าบ็อกซ์

CODE	T=1.0 (ความหนา 1.0 mm.)	Dimension (mm)	PRICE
EB0110	ตั้ 1/2" x 3/4" x 1/2"	2 1/2" x 4" x 1 1/2"	35.00
EBD0110	ลึ้ก 1/2" x 3/4" x 1/2"	2 1/2" x 4" x 2"	40.00

CODE	T=1.2 (ความหนา 1.2 mm.)	Dimension (mm)	PRICE
EB0112	ตั้ 1/2" x 3/4" x 1/2"	2 1/2" x 4" x 1 1/2"	45.00
EBD0112	ลึ้ก 1/2" x 3/4" x 1/2"	2 1/2" x 4" x 2"	57.00

OCTAGON BOX

อ็อกตาگونบ็อกซ์

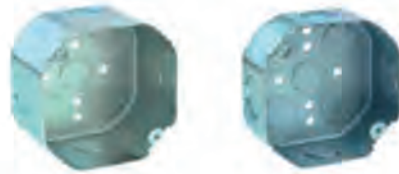

T = 0.8 mm. (รุ่นธรรมดา)

CODE	REF.NAME	Dimension (mm)		PRICE (BAHT)
		A		
OB01	ตัน	1 1/2" DEEP	38	13.00
OBD01	ลึก	2" DEEP	50	17.00

T = 1.0 mm. (รุ่นหนา 1.0 มม.)

CODE	REF.NAME	Dimension (mm)		PRICE (BAHT)
		A		
OB01	ตัน	1 1/2" DEEP	38	33.00
OBD01	ลึก	2" DEEP	50	42.00

T = 1.2 mm. (รุ่นหนา 1.2 มม.)

CODE	REF.NAME	Dimension (mm)		PRICE (BAHT)
		A		
OB01	ตัน	1 1/2" DEEP	38	46.00
OBD01	ลึก	2" DEEP	50	56.00

COVER PLATE FOR OCTAGON BOX T=0.6

ฝาปิดอ็อกตาگونบ็อกซ์ รุ่นธรรมดา T=0.6



CODE	REF.NAME	PRODUCT	PRICE
OBC01	ปิดมิด	BLANK COVER	5.00
OBC02	น็อกครู	1/2" KNOCKOUTS	5.25
OBC03	เสริมูนกลม	CIRCULAR DEVICE 1/4" RAISED	16.00

COVER PLATE FOR OCTAGON BOX T=0.8

ฝาปิดอ็อกตาگونบ็อกซ์ รุ่นหนา T=0.8

CODE	REF.NAME	PRODUCT	PRICE
OBC04	ปิดมิด	BLANK COVER	10.50
OBC05	น็อกครู	1/2" KNOCKOUTS	10.50
OBC06	เสริมูนกลม	CIRCULAR DEVICE 1/4" RAISED	21.00

FS BOX 2" X 4"

เอฟ.เอส.บ็อกซ์ 2" x 4"

CODE	ชนิดสินค้า	SIZE	PRICE
FS2401	1 ทาง (FS)	1/2"	54.00
FS2402		3/4"	54.00
FS2403		1"	64.00
FSS2401	2 ทางรูคู่ (FSS)	1/2"	58.50
FSS2402		3/4"	58.50
FSC2401	2 ทาง ตรงข้าม (FSC)	1/2"	58.50
FSC2402		3/4"	58.50
FSC2403		1"	73.00
FSCC2401	3 ทาง (FSCC)	1/2"	73.00
FSCC2402		3/4"	73.00



FS BOX 4" X 4"

เอฟ.เอส.บ็อกซ์ 4" x 4"

CODE	ชนิดสินค้า	SIZE	PRICE
FS4401	1 ทาง (FS)	1/2"	80.25
FS4402		3/4"	80.25
FS4403		1"	87.75
FSS4401	2 ทางรูคู่ (FSS)	1/2"	84.75
FSS4402		3/4"	84.75
FSC4401	2 ทาง ตรงข้าม (FSC)	1/2"	84.75
FSC4402		3/4"	84.75
FSC4403		1"	96.50
FSCC4401	3 ทาง (FSCC)	1/2"	92.00
FSCC4402		3/4"	92.00



COVER PLATE FOR F.S. BOX 2" X 4"

ฝาปิด เอฟ.เอส.บ็อกซ์ 2" X 4" (รุ่นหนา)

CODE	REF.NAME	PRODUCT	PRICE
FSC24-01	ปิดมิด	BLANK COVER	11.25
FSC24-02	สวิตช์	TOGGLE SWITCH	11.25
FSC24-03	ปลั๊กคู่	DUPLEX RECEPTACLE	11.25
FSC24-04	ปลั๊กเล็ก	SINGLE RECEPTACLE 1.4"	11.25
FSC24-05	ปลั๊กกลาง	SINGLE RECEPTACLE 1.6"	11.25
FSC24-06	ปลั๊กใหญ่	SINGLE RECEPTACLE 1.8"	11.25



COVER PLATE FOR F.S. BOX 4" X 4"

ฝาปิด เอฟ.เอส.บ็อกซ์ 4" X 4" (รุ่นหนา)

CODE	REF.NAME	PRODUCT	PRICE
FSC44-01	ปิดมิด	BLANK COVER	24.00
FSC44-02	สวิตช์ + สวิตช์	TOGGLE SWITCH + TOGGLE SWITCH	24.00
FSC44-03	ปลั๊กคู่ + สวิตช์	DUPLEX RECEPTACLE + TOGGLE SWITCH	24.00
FSC44-04	ปลั๊กคู่ + ปลั๊กคู่	DUPLEX RECEPTACLE + DUPLEX RECEPTACLE	24.00



1 WAY FS BOX 3" X 5"

เอฟ.เอส.บ็อกซ์ 3" x 5" 1 ทาง

CODE	SIZE	PRICE
FS3501	1/2"	168.00
FS3502	3/4"	168.00



CONDUITS BODIES & JUNCTION BOXES



CONDUIT BODY L.B.
คอนดุกทบอดี้ L.B.

CODE	SIZE	PRICE
LB01	1/2"	35.00
LB02	3/4"	41.00
LB03	1"	58.00
LB04	1 1/4"	102.00
LB05	1 1/2"	110.00
LB06	2"	190.00
LB07	2 1/2"	365.00
LB08	3"	409.00
LB09	3 1/2"	803.00
LB10	4"	803.00



CONDUIT BODY L.R.
คอนดุกทบอดี้ L.R.

CODE	SIZE	PRICE
LR01	1/2"	35.00
LR02	3/4"	41.00
LR03	1"	58.00
LR04	1 1/4"	102.00
LR05	1 1/2"	110.00
LR06	2"	190.00
LR07	2 1/2"	365.00
LR08	3"	409.00
LR09	3 1/2"	803.00
LR10	4"	803.00



CONDUIT BODY O.C.
คอนดุกทบอดี้ O.C.

CODE	SIZE	PRICE
OC01	1/2"	35.00
OC02	3/4"	41.00
OC03	1"	58.00



CONDUIT BODY L.L.
คอนดุกทบอดี้ L.L.

CODE	SIZE	PRICE
LL01	1/2"	35.00
LL02	3/4"	41.00
LL03	1"	58.00
LL04	1 1/4"	102.00
LL05	1 1/2"	110.00
LL06	2"	190.00
LL07	2 1/2"	365.00
LL08	3"	409.00
LL09	3 1/2"	803.00
LL10	4"	803.00



CONDUIT BODY O.T.
คอนดุกทบอดี้ O.T.

CODE	SIZE	PRICE
OT01	1/2"	41.00
OT02	3/4"	47.00
OT03	1"	61.00
OT04	1 1/4"	118.00
OT05	1 1/2"	128.00
OT06	2"	219.00
OT07	2 1/2"	387.00
OT08	3"	460.00



CONDUIT BODY T.B.
คอนดุกทบอดี้ T.B.

CODE	SIZE	PRICE
TB01	1/2"	41.00
TB02	3/4"	47.00
TB03	1"	61.00
TB04	1- 1/4"	118.00
TB05	1- 1/2"	128.00
TB06	2"	219.00

CONDUITS BODIES & JUNCTION BOXES



GUAE 1 WAY



GUAC 2 WAY 180



GUAL 2 WAY 90



GUAT 3 WAY



GUAX 4 WAY

CIRCULAR BOX

บ็อกกลมกันน้ำ

CODE	SIZE	PRICE				
		GUAE	GUAC	GUAL	GUAT	GUAX
CCB01	1/2"	93.50	98.00	98.00	105.00	117.00
CCB02	3/4"	93.50	98.00	98.00	105.00	117.00
CCB03	1"	102.00	117.00	117.00	137.00	149.00
CCB04	1 1/4"	205.00	234.00	234.00	263.00	321.00
CCB05	1 1/2"	205.00	234.00	234.00	263.00	321.00
CCB06	2"	584.00	657.00	657.00	730.00	803.00



SERVICE ENTRANCE CAP

หัวงแห่า

CODE	SIZE	TYPE OF LOCK	PRICE
EC01	1/2"	หัวจับแบบ แคล้ม	33.50
EC02	3/4"		45.25
EC03	1"		55.50
EC04	1- 1/4"		70.00
EC05	1- 1/2"		89.00
EC06	2"	หัวจับแบบ เกลียว	153.00
EC07	2-1/2"		333.00
EC08	3"		409.00
EC09	3-1/2"		473.00
EC10	4"		473.00
EC11	5"		1,680.00
EC12	6"		2,200.00

OUTLET BOX

บ็อกซุ่หุ่ยน

CODE	ชนิดสินค้า	PRICE	
		1/2"/A	3/4"/B
OLB01*	OUTLET BOX 1 WAY	93.50	93.50
OLB02*	OUTLET BOX 2 WAYS	98.00	98.00
OLB03*	OUTLET BOX 3 WAYS	105.00	105.00
OLB04*	OUTLET BOX 4 WAYS	117.00	117.00



BALL FLANGE

ฝาแป้นลูกหมาก

CODE	SIZE	PRICE
OC01	1/2"	51.00
OC02	3/4"	51.00



LIGHTING PROTECTION & GROUNDING CONNECTION



AIR TERMINAL BASE ฐานล่อฟ้า

ชนิดสินค้า	PRICE
ฐานล่อฟ้าแบบเรียบ	700.00
ฐานล่อฟ้าแบบจั่ว	700.00
ฐานล่อฟ้าแบบกลม	700.00
ฐานล่อฟ้าแบบห้าเหลี่ยมเกาะพื้น	900.00
ฐานล่อฟ้าแบบห้าเหลี่ยมเกาะผนัง	-

ชนิดสินค้า	PRICE
ฐานล่อฟ้าแบบสี่เหลี่ยมสองสกรู	-
ฐานล่อฟ้าแบบสองชั้น	900.00
ฐานล่อฟ้าแบบสี่เหลี่ยมสี่สกรู	-
ฐานล่อฟ้าแบบกากบาทติดพื้น	900.00
ฐานล่อฟ้าแบบปรับมุม	1,300.00

AIR TERMINAL ROD เสาล่อฟ้า



ชนิดสินค้าปลายแหลม 5/8"	
ขนาด x ความยาว	PRICE
5/8" x 50 ซม.	900.00
5/8" x 60 ซม.	1,070.00
5/8" x 100 ซม.	1,770.00
5/8" x 150 ซม.	2,650.00
5/8" x 200 ซม.	4,200.00

ชนิดสินค้าปลายเกลียว 5/8"	
ขนาด x ความยาว	PRICE
5/8" x 50 ซม.	900.00
5/8" x 60 ซม.	1,070.00
5/8" x 100 ซม.	1,770.00
5/8" x 150 ซม.	2,650.00
5/8" x 200 ซม.	4,200.00

ชนิดสินค้าปลายแหลม 3/4"	
ขนาด x ความยาว	PRICE
5/8" x 50 ซม.	1,400.00
5/8" x 60 ซม.	1,720.00
5/8" x 100 ซม.	2,880.00
5/8" x 150 ซม.	4,330.00
5/8" x 200 ซม.	5,780.00

ชนิดสินค้าปลายแหลม 3/4"	
ขนาด x ความยาว	PRICE
5/8" x 50 ซม.	1,400.00
5/8" x 60 ซม.	1,720.00
5/8" x 100 ซม.	2,880.00
5/8" x 150 ซม.	4,330.00
5/8" x 200 ซม.	5,780.00

AIR TERMINAL ล่อฟ้าสามแฉก



CODE	SIZE	PRICE
AT01	1/2"	260.00
AT02	5/8"	260.00
AT03	3/4"	260.00

GROUND ROD

กราวด์หลอดทองแดง

COPPER 5/8"		
CODE	DIAMETER X LENGTH	PRICE
GR5801	5/8" x 6 ft	160.00
GR5802	5/8" x 8 ft	300.00
GR5803	5/8" x 10 ft	360.00
COPPER 3/4"		
CODE	DIAMETER X LENGTH	PRICE
GR3401	3/4" x 6ft	390.00
GR3402	3/4" x 8 ft	580.00
GR3403	3/4" x 10 ft	700.00



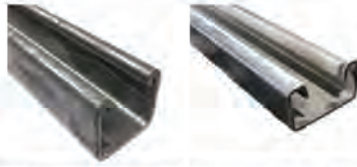

C-CHANNEL

รางตัวซี

CODE	REF.NAME	THICKNESS	DIMENSION (mm)	PRICE
CCN08	ตัน	0.80 มม.	25 x 40 x 1200	80.00
CCN10	ตัน	1.00 มม.	25 x 40 x 1200	90.00
CCN12	ตัน	1.20 มม.	25 x 40 x 1200	120.00
CCND12	ลึก	1.20 มม.	40 x 40 x 1200	180.00
CCND15	ลึกหนา	1.50 มม.	40 x 40 x 1200	240.00



ชุบสัง



ชุบขาว

EMT CONDUIT CLIP FOR C-CHANNEL

แคล้มประกับริงรางตัวซี - ท่อนาง E.M.T.

CODE	SIZE	THICKNESS	PRICE
ECC01	½"	1.00 มม.	5.50
ECC02	¾"	1.00 มม.	6.50
ECC03	1"	1.00 มม.	7.25
ECC04	1 ¼"	1.50 มม.	8.75
ECC05	1 ½"	1.50 มม.	11.25
ECC06	2"	1.50 มม.	12.75

IMC CONDUIT CLIP FOR C-CHANNEL

แคล้มประกับริงรางตัวซี - ท่อนาง I.M.C.

CODE	SIZE	THICKNESS	PRICE
ICC01	½"	1.00 มม.	5.50
ICC02	¾"	1.00 มม.	6.50
ICC03	1"	1.00 มม.	7.25
ICC04	1 ¼"	1.50 มม.	8.75
ICC05	1 ½"	1.50 มม.	11.25
ICC06	2"	1.50 มม.	12.75
ICC07	2 ½"	1.50 มม.	15.25
ICC08	3"	1.50 มม.	17.50
ICC09	3 ½"	1.50 มม.	24.00
ICC10	4"	2.00 มม.	25.75
ICC11	5"	2.30 มม.	64.00



PIPE HANGER

แคล้มแขวน (ชุบขาว / ชุบสัง)

CODE	SIZE		PRICE
	เบอร์	SIZE	
PH01	# 15	1/2"	22.00
PH02	# 20	3/4"	24.00
PH03	# 25	1"	25.00
PH04	# 32	1 ¼"	27.00
PH05	# 40	1 ½"	28.00
PH06	# 50	2"	31.00
PH07	# 65	2 ½"	36.00
PH08	# 80	3"	40.00
PH09	# 100	4"	45.00
PH10	# 125	5"	105.00
PH11	#150	6"	120.00
PH12	#200	8"	315.00

EARTH TAG



CODE	ENTRY THREAD SIZE
ET20	1/2"
ET25	3/4"
ET32	1"
ET40	1-1/4"
ET50	1-1/2"
ET63	2"
ET75	2-1/2"
ET90	3"
ET100	3-1/2"
ET115	4"



PULL BOX พูลบ็อกซ์

CODE	SIZE (W x H x D)	PRICE
PB01	4 x 4 x 4	50.00
PB02	6 x 6 x 4	70.00
PB03	6 x 8 x 4	80.00
PB04	8 x 8 x 4	98.00
PB05	8 x 8 x 6	145.00
PB06	10 x 10 x 4	180.00
PB07	10 x 10 x 6	200.00
PB08	10 x 10 x 8	220.00
PB09	12 x 12 x 4	220.00
PB10	12 x 12 x 6	250.00
PB11	12 x 12 x 8	340.00
PB12	14 x 14 x 4	340.00
PB13	14 x 14 x 6	360.00
PB14	14 x 14 x 8	380.00
PB15	16 x 16 x 4	360.00
PB16	16 x 16 x 6	380.00
PB17	16 x 16 x 8	420.00

WIRE WAY (LENGTH 2400 mm)



CODE	Dimension (W x H) (mm)	PRICE (BAHT)			
		T=1.0 mm / 10	T=1.2 mm / 12	T=1.6 mm / 16	T=2.0 mm
WW01**	50 x 50	380.00	452.00	595.00	740.00
WW02**	75 x 50	448.00	532.00	712.00	893.00
WW03**	100 x 50	543.00	649.00	866.00	1,082.00
WW04**	100 x 75	586.00	704.00	938.00	1,173.00
WW05**	100 x 100	686.00	812.00	1,092.00	1,353.00
WW06**	150 x 100	838.00	1,010.00	1,344.00	1,677.00
WW07**	200 x 100	1,010.00	1,218.00	1,605.00	2,011.00
WW08**	250 x 100		1,327.00	1,759.00	2,209.00
WW09**	300 x 100		1,507.00	2,011.00	2,515.00
WW10**	350 x 100		1,687.00	2,263.00	2,821.00
WW11**	400 x 100		1,920.00	2,569.00	3,210.00
WW12**	450 x 100			2,821.00	3,516.00
WW13**	500 x 100			3,129.00	3,913.00
WW14**	550 x 100			3,309.00	4,148.00
WW15**	600 x 100			3,516.00	4,400.00
WW16**	700 x 100			4,020.00	5,030.00
WW17**	750 x 100			4,326.00	5,418.00

WIRE WAY HANGER SUPPORT

ตัวแขวนรางไฟร้อย



CODE	Dimension (W x H) (mm)	PRICE T = 2.0
HS - WP01	75 x 50	60.00
HS - WP02	100 x 50	70.00
HS - WP03	100 x 75	75.00
HS - WP04	100 x 100	80.00
HS - WP05	150 x 100	85.00
HS - WP06	200 x 100	110.00

90 degree WIREWAY ACCESSORIES อุปกรณ์เสริมรางไวร์เวย์ งอฉาก



อุปกรณ์เสริมรางไวร์เวย์ งอฉาก
90° HORIZONTAL BEND (ELBOW)
(90HB)



อุปกรณ์เสริมรางไวร์เวย์ งอฉากเปิดฝาด้านนอก
90° VERTICAL OUTSIDE (RISER)
(90VO)



อุปกรณ์เสริมรางไวร์เวย์ งอฉากเปิดฝาด้านใน
90° VERTICAL INSIDE (RISER)
(90VI)

CODE	Dimension (W x H) (mm)	PRICE (Baht/Unit)				
		T = 0.8	T=1.0	T=1.2	T=1.6	T=2.0
90 (HB/VO/VI) - WP01	75 x 50	150.00	255.00	280.00	350.00	440.00
90 (HB/VO/VI) - WP02	100 x 50	160.00	265.00	295.00	380.00	450.00
90 (HB/VO/VI) - WP03	100 x 75	170.00	280.00	330.00	410.00	500.00
90 (HB/VO/VI) - WP04	100 x 100	190.00	295.00	345.00	430.00	525.00
90 (HB/VO/VI) - WP05	150 x 100	250.00	360.00	410.00	510.00	645.00
90 (HB/VO/VI) - WP06	200 x 100	320.00	430.00	495.00	595.00	740.00
90 (HB/VO/VI) - WP07	250 x 100	495.00		540.00	670.00	835.00
90 (HB/VO/VI) - WP08	300 x 100			640.00	790.00	980.00
90 (HB/VO/VI) - WP09	350 x 100			730.00	910.00	1,125.00
90 (HB/VO/VI) - WP10	400 x 100			850.00	1,050.00	1,300.00
90 (HB/VO/VI) - WP11	450 x 100				1,195.00	1,490.00
90 (HB/VO/VI) - WP12	500 x 100				1,360.00	1,690.00
90 (HB/VO/VI) - WP13	550 x 100				1,515.00	1,905.00
90 (HB/VO/VI) - WP14	600 x 100				1,670.00	2,120.00
90 (HB/VO/VI) - WP15	650 x 100					2,370.00
90 (HB/VO/VI) - WP16	700 x 100					2,630.00

HORIZONTAL TEE

อุปกรณ์เสริมรางไวร์เวย์ 3 ทิศ



CODE	Dimension (W x H) (mm)	PRICE (Baht/Unit)				
		T = 0.8	T=1.0	T=1.2	T=1.6	T=2.0
HT - WP01	75 x 50	225.00	330.00	375.00	450.00	560.00
HT - WP02	100 x 50	240.00	345.00	385.00	470.00	585.00
HT - WP03	100 x 75	255.00	360.00	410.00	510.00	645.00
HT - WP04	100 x 100	285.00	375.00	430.00	525.00	655.00
HT - WP05	150 x 100	375.00	430.00	505.00	595.00	765.00
HT - WP06	200 x 100	480.00	505.00	570.00	715.00	870.00
HT - WP07	250 x 100	740.00		660.00	810.00	1,020.00
HT - WP08	300 x 100			770.00	945.00	1,165.00
HT - WP09	350 x 100			860.00	1,065.00	1,320.00
HT - WP10	400 x 100			980.00	1,210.00	1,500.00
HT - WP11	450 x 100				1,370.00	1,705.00
HT - WP12	500 x 100				1,525.00	1,920.00
HT - WP13	550 x 100				1,720.00	2,120.00
HT - WP14	600 x 100				1,910.00	2,370.00
HT - WP15	650 x 100					2,630.00
HT - WP16	700 x 100					2,895.00



PULL BOX, WIRE WAY & ACCESSORIES

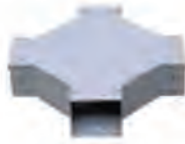

HORIZONTAL CROSS

อุปกรณ์เสริมรางไวร์เวย์ 4 ทิศ

CODE	Dimension (W x H) (mm)	PRICE (Baht/Unit)				
		T = 0.8	T=1.0	T=1.2	T=1.6	T=2.0
HX - WP01	75 x 50	300.00	400.00	465.00	570.00	705.00
HX - WP02	100 x 50	320.00	410.00	495.00	585.00	740.00
HX - WP03	100 x 75	340.00	440.00	520.00	645.00	790.00
HX - WP04	100 x 100	380.00	480.00	530.00	675.00	810.00
HX - WP05	150 x 100	500.00	530.00	625.00	765.00	945.00
HX - WP06	200 x 100	640.00	650.00	760.00	920.00	1,135.00
HX - WP07	250 x 100	990.00		850.00	1,050.00	1,310.00
HX - WP08	300 x 100			970.00	1,195.00	1,465.00
HX - WP09	350 x 100			1,100.00	1,360.00	1,670.00
HX - WP10	400 x 100			1,230.00	1,515.00	1,890.00
HX - WP11	450 x 100				1,705.00	2,095.00
HX - WP12	500 x 100				1,890.00	2,340.00
HX - WP13	550 x 100				2,095.00	2,605.00
HX - WP14	600 x 100				2,300.00	2,880.00
HX - WP15	650 x 100					3,170.00
HX - WP16	700 x 100					3,490.00

HOT DIP GALVANISED CONDUIT FITTINGS & ACCESSORIES

THE ULTIMATE TOUGHNESS



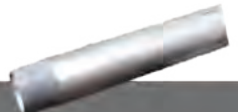

EMT CONDUIT HOT DIP GALVANISED		
CODE	SIZE	PRICE
HECD01	1/2"	133.00
HECD02	3/4"	192.00
HECD03	1"	273.00
HECD04	1 1/4"	476.00
HECD05	1 1/2"	555.00
HECD06	2"	688.00

IMC CONDUIT HOT DIP GALVANISED		
CODE	SIZE	PRICE
HICD01	1/2"	424.00
HICD02	3/4"	564.00
HICD03	1"	760.00
HICD04	1 1/4"	980.00
HICD05	1 1/2"	1,204.00
HICD06	2"	1,644.00
HICD07	2 1/2"	1,979.00
HICD08	3"	2,543.00
HICD09	3 1/2"	3,335.00
HICD10	4"	3,747.00

RSC CONDUIT HOT DIP GALVANISED		
CODE	SIZE	PRICE
HRCD01	1/2"	342.00
HRCD02	3/4"	436.00
HRCD03	1"	641.00
HRCD04	1 1/4"	828.00
HRCD05	1 1/2"	985.00
HRCD06	2"	1,317.00
HRCD07	2 1/2"	1,979.00
HRCD08	3"	2,543.00
HRCD09	3 1/2"	3,335.00
HRCD10	4"	3,747.00
HRCD11	5"	5,389.00
HRCD12	6"	6,449.00



Flexible conduit		
CODE	SIZE	PRICE
FC01	1/2"	18.00
FC02	3/4"	24.00
FC03	1"	36.00
FC04	1 1/4"	66.00
FC05	1 1/2"	90.00
FC06	2"	110.00
FC07	2 1/2"	200.00
FC08	3"	240.00
FC09	4"	450.00



Flexible liquid tight		
CODE	SIZE	PRICE
FCRT01	1/2"	31.00
FCRT02	3/4"	41.00
FCRT03	1"	68.00
FCRT04	1 1/4"	82.00
FCRT05	1 1/2"	110.00
FCRT06	2"	138.00
FCRT07	2 1/2"	276.00
FCRT08	3"	414.00
FCRT09	4"	550.00



Flexible conduit interlock		
CODE	SIZE	PRICE
FCI01	1/2"	18.00
FCI02	3/4"	24.00
FCI03	1"	36.00
FCI04	1 1/4"	66.00
FCI05	1 1/2"	90.00
FCI06	2"	110.00
FCI07	2 1/2"	200.00
FCI08	3"	240.00
FCI09	4"	450.00



Flexible conduit lowsmoke zero halogen			
CODE	SIZE	LENGTH	PRICE
HFCLS01	1/2"	30 M	5,625.00
HFCLS02	3/4"	30 M	6,772.50
HFCLS03	1"	30 M	10,338.75
HFCLS04	1 1/4"	15 M	4,950.00
HFCLS05	1 1/2"	15 M	8,550.00
HFCLS06	2"	15 M	11,756.25

HOT DIP GALVANISED CONDUIT BOX AND ACCESSORIES

ELBOW 90 EMT HOT DIP GALVANISED



RAW MATERIAL : STEEL PIPE
FINISHING : ZINC HOT DIP GALVANISED

CODE	SIZE	PRICE
HELBE01	1/2"	56.00
HELBE02	3/4"	62.00
HELBE03	1"	116.00
HELBE04	1 1/4"	190.00
HELBE05	1 1/2"	246.00
HELBE06	2"	340.00

ELBOW 90 IMC HOT DIP GALVANISED



RAW MATERIAL : STEEL PIPE
FINISHING : ZINC HOT DIP GALVANISED

CODE	SIZE	PRICE
HELBI01	1/2"	90.00
HELBI02	3/4"	116.00
HELBI03	1"	190.00
HELBI04	1 1/4"	246.00
HELBI05	1 1/2"	340.00
HELBI06	2"	510.00
HELBI07	2 1/2"	1250.00
HELBI08	3"	2100.00
HELBI09	3 1/2"	3500.00
HELBI10	4"	4080.00

ELBOW 90 RSC HOT DIP GALVANISED

RAW MATERIAL : STEEL PIPE
FINISHING : ZINC HOT DIP GALVANISED

CODE	SIZE	PRICE
HELBR01	1/2"	130.00
HELBR02	3/4"	150.00
HELBR03	1"	240.00
HELBR04	1 1/4"	400.00
HELBR05	1 1/2"	450.00
HELBR06	2"	730.00

CODE	SIZE	PRICE
HELBR07	2 1/2"	1590.00
HELBR08	3"	2450.00
HELBR09	3 1/2"	4050.00
HELBR10	4"	4900.00
HELBR11	5"	13800.00
HELBR12	6"	17900.00

INTERLOCK FLEXIBLE CONDUIT CONNECTOR HOT DIP GALVANISED



RAW MATERIAL : STEEL
FINISHING : ZINC HOT DIP GALVANISED

CODE	SIZE	PRICE
HILFCN01	1/2"	210.00
HILFCN02	3/4"	308.00
HILFCN03	1"	470.00
HILFCN04	1 1/4"	580.00
HILFCN05	1 1/2"	770.00
HILFCN06	2"	1414.00
HILFCN07	2 1/2"	PENDING
HILFCN08	3"	PENDING
HILFCN09	3 1/2"	PENDING

LOW SMOKE ZH LIQUID TIGHT FLEXIBLE CONDUIT CONNECTOR HOT DIP GALVANISED



RAW MATERIAL : STEEL
FINISHING : ZINC HOT DIP GALVANISED

CODE	SIZE	PRICE
HLSFCN01	1/2"	275.00
HLSFCN02	3/4"	400.00
HLSFCN03	1"	620.00
HLSFCN04	1 1/4"	PENDING
HLSFCN05	1 1/2"	PENDING
HLSFCN06	2"	PENDING
HLSFCN07	2 1/2"	PENDING
HLSFCN08	3"	PENDING
HLSFCN09	3 1/2"	PENDING



HOT DIP GALVANISED CONDUIT FITTING ACCESSORIES

RAW MATERIAL

STAINLESS STEEL SUS 304
 SIZE 1/4" - 5/16"
 STEEL ROD SIZE 3/8" - 1/2"

FINISHING

ZINC HOT DIP GALVANISED



STUD THREAD ROD HOT DIP GALVANISED

CODE	SIZE	LENGTH (mm)	PRICE
TR 0110	1/4"	1000	130.67
TR 0210	5/16"	1000	196.00
TR 0310H	3/8"	1000	86.67
TR 0410H	1/2"	1000	130.67

CODE	SIZE	LENGTH (mm)	PRICE
TR0115	1/4"	1500	196.00
TR0215	5/16"	1500	294.00
TR0315H	3/8"	1500	130.00
TR0415H	1/2"	1500	196.00

CODE	SIZE	LENGTH (mm)	PRICE
TR0120	1/4"	2000	261.33
TR0220	5/16"	2000	392.00
TR0320H	3/8"	2000	173.33
TR0420H	1/2"	2000	261.33
TR0430	1/4"	3000	350.00
TR0430	5/16"	3000	390.00
TR0430H	3/8"	3000	420.00
TR0430H	1/2"	3000	580.00



ROUND WASHER HOT DIP GALVANISED

CODE	SIZE	PRICE
RW01	1/4"	4.00
RW02	5/16"	5.00
RW03H	3/8"	6.00
RW04H	1/2"	8.00



HEXAGONAL COUPLING HOT DIP GALVANISED

CODE	SIZE	PRICE
TRC01	1/4"	30.00
TRC02	5/16"	30.00
TRC03H	3/8"	30.00
TRC04H	1/2"	50.00



ROUND SPRING WASHER HOT DIP GALVANISED

CODE	SIZE	PRICE
RSW01	1/4"	3.00
RSW02	5/16"	4.00
RSW03H	3/8"	5.00
RSW04H	1/2"	6.00



SCREWS AND NUT HOT DIP GALVANISED

CODE	SIZE	PRICE
SC01	1/4"	6.00
SC02	5/16"	8.00
SC03H	3/8"	10.00
SC04H	1/2"	15.00



HOT DIP GALVANISED CONDUIT FITTING ACCESSORIES

SQUARE WASHER

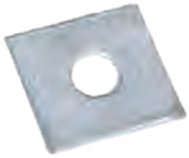

CODE	SIZE	PRICE
SW01H	1/2" T2.5	12.00
SW02H	5/8" T2.5	16.00
SW03H	5/8" T4.5	24.00

SCREWS AND NUTS

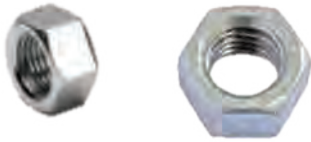

RAW MATERIAL : STAINLESS STEEL SUS304
 SIZE 1/4" - 5/16"
 STEEL SHEET SIZE 3/8" - 1/2"
 FINISHING : ZINC HOT DIP GALVANISED

CODE	SIZE	PRICE
SCN01	1/4"	3.00
SCN02	5/16"	4.00
SCN03H	3/8"	5.00
SCN04H	1/2"	6.00

STRAP AND BACK PLATE FOR STRAP



RAW MATERIAL : MILD STEEL
 FINISHING : ZINC HOT DIP GALVANISED

STRAPS			STRAP BACK PLATE	
CODE	SIZE	PRICE	CODE	PRICE
C2L01H	1/2"	10.00	HBPS01	12.00
C2L02H	3/4"	12.00	HBPS02	14.00
C2L03H	1"	14.00	HBPS03	16.00
C2L04H	1 1/4"	18.00	HBPS04	22.00
C2L05H	1 1/2"	24.00	HBPS05	28.00
C2L06H	2"	32.00	HBPS06	38.00
C2L07H	2 1/2"	62.00	HBPS07	75.00
C2L08H	3"	72.00	HBPS08	85.00
C2L09H	3 1/2"	96.00	HBPS09	110.00
C2L10H	4"	110.00	HBPS10	140.00

C-CHANNEL



RAW MATERIAL : MILD STEEL SHEET
 FINISHING : ZINC HOT DIP GALVANISED

CODE	TYPE	T	(C x D x L)	PRICE
CCN16HDG12	ตั้ง	1.60	25 x 40 x 1200	360.00
CCND16HDG12	ล็อก	1.60	40 x 40 x 1200	480.00
CCN16HDG24	ตั้ง	1.60	25 x 40 x 2400	720.00
CCND16HDG24	ล็อก	1.60	40 x 40 x 2400	960.00
CCN16HDG24	ตั้ง	1.60	25 x 40 x 3000	1,200.00
CCND16HDG24	ล็อก	1.60	40 x 40 x 3000	1,500.00
CCN25HDG24	ตั้ง	2.50	25 x 40 x 2400	1,125.00
CCND25HDG24	ล็อก	2.50	40 x 40 x 2400	1,500.00
CCN25HDG30	ตั้ง	2.50	25 x 40 x 3000	1,700.00
CCND25HDG30	ล็อก	2.50	41.2 x 41.2 x 3000	2,000.00
CCN25HDG40	ตั้ง	2.50	25 x 40 x 4000	2,500.00
CCND25HDG40	ล็อก	2.50	41.2 x 41.2 x 4000	3,300.00

CONDUIT CLAMP FOR C-CHANNEL



RAW MATERIAL MILD STEEL T1.5 SIZE 1/2" - 4"
 MILD STEEL T2.0 SIZE 5" - 6"
 FINISHING : ZINC HOT DIP GALVANISED

CODE	SIZE	PRICE
RCC01	1/2"	28.00
RCC02	3/4"	32.00
RCC03	1"	34.00
RCC04	1 1/4"	36.00
RCC05	1 1/2"	44.00
RCC06	2"	48.00
RCC07	2 1/2"	60.00
RCC08	3"	66.00
RCC09	3 1/2"	80.00
RCC10	4"	90.00
RCC11	5"	150.00
RCC12	6"	220.00



HOT DIP GALVANISED CONDUIT FITTING ACCESSORIES

RAW MATERIAL

MILD STEEL T1.2/ T1.6

FINISHING

ZINC HOT DIP GALVANISED



SQUARE BOX HOT DIP GALVANISED

CODE	DESCRIPTION	T1.2	T1.6
		PRICE	PRICE
SB01H	ตีบ 1/2" - 3/4" - 1/2"	100.00	160.00
SB02H	ตีบ 1 นิ้ว	120.00	160.00
SB01ERH	ตีบ 1 นิ้ว กั้น:ฯ	120.00	160.00
SBD01H	ลึก 1/2" - 3/4" - 1/2"	180.00	210.00
SBD02H	ตีบ 3/4"	180.00	210.00
SBD03H	ลึก 3/4" / 1"	180.00	210.00
SBD04H	ลึก 1"	180.00	210.00
SBD05H	ลึก 1 นิ้ว	180.00	210.00
SBD01ERH	ลึก 1 ลึก กั้น:ฯ	200.00	270.00
SBD02ERH	ลึก 1 นิ้ว กั้น:ฯ	200.00	270.00



HANDY BOX HOT DIP GALVANISED

CODE	DESCRIPTION	T1.2	T1.6
		PRICE	PRICE
HB01H	ตีบ 1/2" - 3/4" - 1/2"	80.00	140.00
HB02H	ตีบ 1 นิ้ว	80.00	140.00
HB01ERH	ตีบ 1 นิ้ว กั้น:ฯ	80.00	140.00
HBD01H	ลึก 1/2" - 3/4" - 1/2"	110.00	170.00
HBD02H	ลึก 3/4"	110.00	170.00
HBD03H	ลึก 1 นิ้ว	110.00	170.00
HBD01ERH	ลึก กั้น:ฯ	110.00	210.00

RAW MATERIAL

MILD STEEL T1.2 / T1.6

FINISHING

ZINC HOT DIP GALVANISED



COVER FOR SQUARE BOX (NORMAL) COVER FOR SQUARE BOX DEEP HOT DIP GALVANISED

CODE	DESCRIPTION	PRICE
SBC 01 H	ฝาปิด Square Box 4x4 ตีบ T1.2	44.00
SBDC 01 H	ฝาปิด Square Box 4x4 ลึก T1.2	44.00
SBC 02 H	ฝาปิด Square Box 4x4 ตีบ T1.6	60.00
SBDC 02 H	ฝาปิด Square Box 4x4 ลึก T1.6	60.00
SBC 03 H	ฝาปิด Square Box 4x4 T1.6	90.00
SBC 04 H	ฝาปิด Square Box 4x4 T1.6	90.00



COVER FOR HANDY BOX HOT DIP GALVANISED

CODE	DESCRIPTION	PRICE
HBC01H	ฝาปิด Handy Box 2x4 T1.2	36.00
HBC02H	ฝาปิด Handy Box 2x4 T1.6	49.00

RAW MATERIAL

MILD STEEL T1.2

FINISHING

ZINC HOT DIP GALVANISED



EUROPA BOX HOT DIP GALVANISED

CODE	DESCRIPTION	T1.2	T1.6
		PRICE	PRICE
EB01H	ตัว 1/2" - 3/4" - 1/2"	100.00	170.00
EB02H	ลวด 3/4"	140.00	190.00
EB03H	ลวด 1/2" - 3/4" - 1/2"	140.00	190.00



OCTAGON BOX HOT DIP GALVANISED

CODE	DESCRIPTION	T1.2	T1.6
		PRICE	PRICE
OB01H	ตัว 1/2" - 3/4"	100.00	170.00
OB02H	ลวด 1/2" - 3/4"	180.00	210.00
OB03H	ลวด 3/4" - 1"	180.00	210.00



JUMBO SQUARE BOX 5"x5" HOT DIP GALVANISED

CODE	DESCRIPTION	T1.2	T1.6
		PRICE	PRICE
JSB01H	ลวด 1 นิ้ว	300.00	400.00

RAW MATERIAL

MILD STEEL T1.2 / T1.6

FINISHING

ZINC HOT DIP GALVANISED



COVER FOR EUROPA BOX HOT DIP GALVANISED

CODE	DESCRIPTION	PRICE
EBC01H	ฝาปิด Europa box T1.2	42.00
EBC02H	ฝาปิด Europa box T1.6	57.00



COVER FOR OCTAGON BOX HOT DIP GALVANISED

CODE	DESCRIPTION	PRICE
HBC01H	ฝาปิด Octagon box T1.2	44.00
HBC02H	ฝาปิด Octagon box T1.6	60.00



COVER FOR JUMBO BOX 5"x5" HOT DIP GALVANISED

CODE	DESCRIPTION	PRICE
JSBC01H	ฝาปิด Jumbo square box T1.2	80.00
JSBC02H	ฝาปิด Jumbo square box T1.6	108.00



HOT DIP GALVANISED CONDUIT FITTING ACCESSORIES

RAW MATERIAL

MILD STEEL T1.2

FINISHING

ZINC HOT DIP GALVANISED



MK BOX

HOT DIP GALVANISED

CODE	DESCRIPTION	T1.2	T1.6
		PRICE	PRICE
MKB 01H	3" x 3" ฝั 1/2"	100.00	160.00
MKB 02H	3" x 3" ฝั 1/2" - 3/4"	180.00	210.00
MKB 03H	3" x 5" ฝั 3/4" - 1/2" - 3/4"	290.00	380.00

RAW MATERIAL

MILD STEEL

FINISHING

ZINC HOT DIP GALVANISED



APPLICABLE HANGERS

HOT DIP GALVANISED

CODE	SIZE	PRICE
SC01H	1/2"	22.00
SC02H	3/4"	32.00
SC03H	1"	42.00
SC04H	1 1/4"	54.00
SC05H	1 1/2"	64.00
SC06H	2"	74.00
SC07H	2 1/2"	110.00
SC08H	3"	130.00
SC09H	3 1/2"	190.00
SC10H	4"	240.00

RAW MATERIAL

MILD STEEL

FINISHING

ZINC HOT DIP GALVANISED



BEAM CLAMPS

HOT DIP GALVANISED

CODE	TYPE	BEAM	PRICE
BC01H	I	14 mm.	80.00
BC02H	IW	20 mm.	180.00
BC03H	2W	30 mm.	380.00
BC04H	UB	25 mm.	700.00



IMC/RSC COUPLING

HOT DIP GALVANISED

CODE	SIZE	PRICE
RCP01H	1/2"	34.00
RCP02H	3/4"	44.00
RCP03H	1"	60.00
RCP04H	1 1/4"	100.00
RCP05H	1 1/2"	120.00
RCP06H	2"	160.00
RCP07H	2 1/2"	350.00
RCP08H	3"	430.00
RCP09H	3 1/2"	580.00
RCP10H	4"	670.00
RCP11H	5"	1,100.00

RAW MATERIAL

MILD STEEL

SUS 304 SCREWS

FINISHING

ZINC HOT DIP GALVANISED



PULL BOX

HOT DIP GALVANISED

CODE	TYPE	BEAM	PRICE
HBP101010	1.60	10x10x10	700.00
HBP151510	1.60	15x15x10	1,000.00
HBP151515	1.60	15x15x15	1,060.00
HBP202010	1.60	20x20x10	1,400.00
HBP202015	1.60	20x20x15	1,700.00
HBP202020	1.60	20x20x20	1,900.00
HBP252510	1.60	25x25x10	1,900.00
HBP252515	1.60	25x25x15	2,100.00
HBP252520	1.60	25x25x20	2,400.00
HBP252525	1.60	25x25x25	2,600.00
HBP303015	1.60	30x30x15	2,700.00
HBP303020	1.60	30x30x20	3,000.00
HBP303025	1.60	30x30x25	3,200.00
HBP303030	1.60	30x30x30	3,400.00
HBP404015	1.60	40x40x15	4,200.00
HBP404020	1.60	40x40x20	4,600.00
HBP404025	1.60	40x40x25	4,900.00
HBP404030	1.60	40x40x30	5,300.00
HBP404040	1.60	40x40x40	6,000.00
HBP505020	1.60	50x50x20	7,200.00
HBP505025	2.30	50x50x25	7,800.00
HBP505030	2.30	50x50x30	8,400.00
HBP505040	2.30	50x50x40	9,400.00
HBP505050	2.30	50x50x50	10,400.00
HBP606020	2.30	60x60x20	9,200.00
HBP606030	2.30	60x60x30	11,000.00
HBP606040	2.30	60x60x40	12,000.00
HBP606050	2.30	60x60x50	13,000.00
HBP606060	2.30	60x60x60	15,000.00

RAW MATERIAL

MILD STEEL

FINISHING

ZINC HOT DIP GALVANISED



MILD STEEL BUSHINGS

HOT DIP GALVANISED

CODE	SIZE	PRICE
SBS01H	1/2"	26.00
SBS02H	3/4"	36.00
SBS03H	1"	46.00
SBS04H	1 1/4"	76.00
SBS05H	1 1/2"	110.00
SBS06H	2"	150.00
SBS07H	2 1/2"	240.00
SBS08H	3"	320.00
SBS09H	3 1/2"	460.00
SBS10H	4"	500.00



MILD STEEL LOCKNUTS

HOT DIP GALVANISED

CODE	SIZE	PRICE
LN01H	1/2"	16.00
LN02H	3/4"	22.00
LN03H	1"	28.00
LN04H	1 1/4"	46.00
LN05H	1 1/2"	54.00
LN06H	2"	64.00
LN07H	2 1/2"	120.00
LN08H	3"	176.00
LN09H	3 1/2"	290.00
LN10H	4"	330.00

EMT CONNECTOR R/T
Compression type
HOT DIP GALVANISED



RAW MATERIAL : STEEL
FINISHING : ZINC HOT DIP GALVANISED

CODE	SIZE	PRICE
HCNRT01	1/2"	112.50
HCNRT02	3/4"	175.00
HCNRT03	1"	225.00
HCNRT04	1 1/4"	350.00
HCNRT05	1 1/2"	575.00
HCNRT06	2"	750.00

EMT COUPLING R/T
Compression type
HOT DIP GALVANISED



RAW MATERIAL : STEEL
FINISHING : ZINC HOT DIP GALVANISED

CODE	SIZE	PRICE
HCPRT01	1/2"	125.00
HCPRT02	3/4"	195.00
HCPRT03	1"	235.00
HCPRT04	1 1/4"	450.00
HCPRT05	1 1/2"	650.00
HCPRT06	2"	800.00

FLEXIBLE CONDUIT CONNECTOR
HOT DIP GALVANISED



RAW MATERIAL : STEEL
FINISHING : ZINC HOT DIP GALVANISED

CODE	SIZE	PRICE
HFCN01	1/2"	54.00
HFCN02	3/4"	68.00
HFCN03	1"	95.00
HFCN04	1 1/4"	PENDING
HFCN05	1 1/2"	PENDING
HFCN06	2"	PENDING

CONNECTOR FOR FLEXIBLE CONDUIT
LIQUID TIGHT
HOT DIP GALVANISED



RAW MATERIAL : STEEL
FINISHING : ZINC HOT DIP GALVANISED

CODE	SIZE	PRICE
HFRTCNO1	1/2"	240.00
HFRTCNO2	3/4"	352.00
HFRTCNO3	1"	540.00
HFRTCNO4	1 1/4"	672.00
HFRTCNO5	1 1/2"	880.00
HFRTCNO6	2"	1616.00
HFRTCNO7	2 1/2"	3376.00
HFRTCNO8	3"	3776.00
HFRTCNO9	3 1/2"	4040.00

EMT CONNECTOR
HOT DIP GALVANISED



EMT COUPLING
HOT DIP GALVANISED



RAW MATERIAL : MILD STEEL
FINISHING : ZINC HOT DIP GALVANISED

RAW MATERIAL : MILD STEEL
FINISHING : ZINC HOT DIP GALVANISED

CODE	SIZE	PRICE
ECN01H	1/2"	33.00
ECN02H	3/4"	42.00
ECN03H	1"	58.00
ECN04H	1 1/4"	104.00
ECN05H	1 1/2"	124.00
ECN06H	2"	154.00

CODE	SIZE	PRICE
ECP01H	1/2"	30.00
ECP02H	3/4"	36.00
ECP03H	1"	48.00
ECP04H	1 1/4"	84.00
ECP05H	1 1/2"	108.00
ECP06H	2"	144.00

CHASE NIPPLE
HOT DIP GALVANISED



ANSI/NEMA FB 1 LOCKNUTS
HOT DIP GALVANISED



RAW MATERIAL : CAST IRON
FINISHING : ZINC HOT DIP GALVANISED

RAW MATERIAL : SIZE 1/2"-2" MILD STEEL
SIZE 2 1/2"-5" CAST IRON
FINISHING : ZINC HOT DIP GALVANISED

CODE	SIZE	PRICE
HCNP01	1/2"	55.00
HCNP02	3/4"	66.00
HCNP03	1"	86.00
HCNP04	1 1/4"	116.00
HCNP05	1 1/2"	146.00
HCNP06	2"	226.00

CODE	SIZE	THICKNESS	PRICE
HALN01	1/2"	3.20	20.00
HALN02	3/4"	3.55	30.00
HALN03	1"	4.32	36.00
HALN04	1 1/4"	4.32	54.00
HALN05	1 1/2"	4.32	72.00
HALN06	2"	4.75	100.00
HALN07	2 1/2"	9.52	200.00
HALN08	3"	9.52	320.00
HALN09	3 1/2"	11.20	400.00
HALN10	4"	11.20	450.00
HALN11	5"	12.80	700.00
HALN12	6"	14.30	880.00

HOT DIP GALVANISED CONDUIT BOX AND FITTING ACCESSORIES

GROUNDING BUSHING

HOT DIP GALVANISED



RAW MATERIAL : CAST IRON
FINISHING : ZINC HOT DIP GALVANISED

CODE	SIZE	PRICE
HGBS01	1/2"	110.00
HGBS02	3/4"	130.00
HGBS03	1"	150.00
HGBS04	1 1/4"	200.00
HGBS05	1 1/2"	220.00
HGBS06	2"	260.00
HGBS07	2 1/2"	480.00
HGBS08	3"	560.00
HGBS09	3 1/2"	700.00
HGBS10	4"	820.00
HGBS11	5"	1200.00

ANSI BUSHING

HOT DIP GALVANISED



RAW MATERIAL : CAST IRON
FINISHING : ZINC HOT DIP GALVANISED

CODE	SIZE	PRICE
HANBS01	1/2"	75.00
HANBS02	3/4"	90.00
HANBS03	1"	110.00
HANBS04	1 1/4"	140.00
HANBS05	1 1/2"	165.00
HANBS06	2"	180.00
HANBS07	2 1/2"	330.00
HANBS08	3"	440.00
HANBS09	3 1/2"	560.00
HANBS10	4"	680.00
HANBS11	5"	960.00

CONDUIT BODY LB

HOT DIP GALVANISED



CONDUIT BODY LL

HOT DIP GALVANISED



RAW MATERIAL : CAST IRON
FINISHING : ZINC HOT DIP GALVANISED

CODE	SIZE	PRICE
HLB01	1/2"	300.00
HLB02	3/4"	360.00
HLB03	1"	560.00
HLB04	1 1/4"	900.00
HLB05	1 1/2"	1000.00
HLB06	2"	1500.00
HLB07	2 1/2"	2300.00
HLB08	3"	3000.00
HLB09	3 1/2"	4300.00
HLB10	4"	4500.00

CONDUIT BODY LR

HOT DIP GALVANISED



CODE	SIZE	PRICE
HLL01	1/2"	300.00
HLL02	3/4"	360.00
HLL03	1"	560.00
HLL04	1 1/4"	900.00
HLL05	1 1/2"	1000.00
HLL06	2"	1500.00

CODE	SIZE	PRICE
HLR01	1/2"	300.00
HLR02	3/4"	360.00
HLR03	1"	560.00
HLR04	1 1/4"	900.00
HLR05	1 1/2"	1000.00
HLR06	2"	1500.00

CONDUIT BODY TB
HOT DIP GALVANISED



RAW MATERIAL : CAST IRON
FINISHING : ZINC HOT DIP GALVANISED

CODE	SIZE	PRICE
HTB01	1/2"	350.00
HTB02	3/4"	450.00
HTB03	1"	680.00
HTB04	1 1/4"	1000.00
HTB05	1 1/2"	1400.00
HTB06	2"	1900.00

FS BOX 2" x 4" - 1 WAY
HOT DIP GALVANISED



CODE	SIZE	PRICE
HFS2401	1/2"	420.00
HFS2402	3/4"	420.00
HFS2403	1"	670.00

FS BOX 4" x 4" - 1 WAY
HOT DIP GALVANISED



CODE	SIZE	PRICE
HFS4401	1/2"	840.00
HFS4402	3/4"	840.00
HFS4403	1"	1340.00

CONDUIT BODY OT
HOT DIP GALVANISED



RAW MATERIAL : CAST IRON
FINISHING : ZINC HOT DIP GALVANISED

CODE	SIZE	PRICE
HOT01	1/2"	350.00
HOT02	3/4"	450.00
HOT03	1"	680.00
HOT04	1 1/4"	1000.00
HOT05	1 1/2"	1400.00
HOT06	2"	1900.00

**FSW BOX 2" x 4" - 1 WAY
DEVICE BOX**
HOT DIP GALVANISED



CODE	SIZE	PRICE
HFSWD2401	1/2"	340.00
HFSWD2402	3/4"	340.00

FSW BOX 2" x 4" - 1 WAY
HOT DIP GALVANISED



CODE	SIZE	PRICE
HFSW2401	1/2"	420.00
HFSW2402	3/4"	420.00

HOT DIP GALVANISED CONDUIT BOX AND FITTING ACCESSORIES

FSC BOX 2"x4" - 2 WAYS HOT DIP GALVANISED



BSC BOX 3"x3" - 2 WAY HOT DIP GALVANISED



BS BOX 3"x3" - 1 WAY HOT DIP GALVANISED



RAW MATERIAL : CAST IRON
FINISHING : ZINC HOT DIP GALVANISED

CODE	SIZE	PRICE
HFSC2401	1/2"	460.00
HFSC2402	3/4"	460.00

CODE	SIZE	PRICE
HBSC3301	1/2"	400.00
HBSC3302	3/4"	400.00

CODE	SIZE	PRICE
HSB3301	1/2"	360.00
HSB3302	3/4"	360.00

REDUCER HOT DIP GALVANISED



RAW MATERIAL :CAST IRON
FINISHING :ZINC HOT DIP GALVANISED

CODE	SIZE	PRICE
HRDC01	3/4" to 1/2"	80.00
HRDC02	1" to 1/2"	120.00
HRDC03	1" to 3/4"	120.00
HRDC04	1-1/4" to 1/2"	210.00
HRDC05	1-1/4" to 3/4"	210.00
HRDC06	1-1/4" to 1"	210.00
HRDC07	1-1/2" to 1/2"	270.00
HRDC08	1-1/2" to 3/4"	270.00
HRDC09	1-1/2" to 1"	270.00
HRDC10	1-1/2" to 1-1/4"	270.00
HRDC11	2" to 1/2"	320.00
HRDC12	2" to 3/4"	320.00

CODE	SIZE	PRICE
HRDC13	2" to 1"	320
HRDC14	2" to 1-1/4"	320
HRDC15	2" to 1-1/2"	320
HRDC16	2-1/2" to 1"	600
HRDC17	2-1/2" to 1-1/4"	600
HRDC18	2-1/2" to 1-1/2"	600
HRDC19	2-1/2" to 2"	600
HRDC20	3" to 1-1/4"	1,200
HRDC21	3" to 1-1/2"	1,200
HRDC22	3" to 2"	1,200
HRDC23	3" to 2-1/2"	1,200
HRDC24	3-1/2" to 2"	1,500

CODE	SIZE	PRICE
HRDC25	3-1/2" to 3"	1,500
HRDC26	4" to 1"	1,700
HRDC27	4" to 1-1/4"	1,700
HRDC28	4" to 1-1/2"	1,700
HRDC29	4" to 2"	1,700
HRDC30	4" to 2-1/2"	1,700
HRDC31	4" to 3"	1,700
HRDC32	4" to 3-1/2"	1,700
HRDC33	5" to 4"	2,000
HRDC34	6" to 4"	2,400

CIRCULAR BOX
HOT DIP GALVANISED



SIZE	1 WAY		2 WAYS 180		2 WAYS 90	
	CODE	PRICE	CODE	PRICE	CODE	PRICE
1/2"	HCLB0101	320.00	HCLB0201	360.00	HCLB1201	360.00
3/4"	HCLB0102	320.00	HCLB0202	360.00	HCLB1202	360.00
1"	HCLB0103	400.00	HCLB0203	440.00	HCLB1203	440.00

SIZE	3 WAYS		4 WAYS	
	CODE	PRICE	CODE	PRICE
1/2"	HCLB0301	420.00	HCLB0401	460.00
3/4"	HCLB0302	420.00	HCLB0402	460.00
1"	HCLB0303	480.00	HCLB0403	520.00

JUNCTION BOX
HOT DIP GALVANISED



SIZE	1 WAY		2 WAYS 180		2 WAYS 90	
	CODE	PRICE	CODE	PRICE	CODE	PRICE
1/2"	HJCB0101	440.00	HJCB0201	500.00	HJCB1201	500.00
3/4"	HJCB0102	440.00	HJCB0202	500.00	HJCB1202	500.00
1"	HJCB0103	500.00	HJCB0203	580.00	HJCB1203	580.00
1 1/4"	HJCB0104	-	HJCB0204	1,450.00	HJCB1204	1,450.00
1 1/2"	HJCB0105	-	HJCB0205	1,450.00	HJCB1205	1,450.00
2"	HJCB0106	-	HJCB0206	1,900.00	HJCB1206	1,900.00

SIZE	3 WAYS		4 WAYS	
	CODE	PRICE	CODE	PRICE
1/2"	HJCB0301	560.00	HJCB0401	600.00
3/4"	HJCB0302	560.00	HJCB0402	600.00
1"	HJCB0303	620.00	HJCB0403	660.00
1 1/4"	HJCB0304	1,550.00	HJCB0404	1,650.00
1 1/2"	HJCB0305	1,550.00	HJCB0405	1,650.00
2"	HJCB0306	2,000.00	HJCB0406	2,000.00

**HOT DIP GALVANISED
STRUT CHANNEL , HANGERS
AND SUPPORTS
FOR
MECHANICAL INSTALLATION
WORK**

HDPE PIPE CLAMP SET - TYPE A
HOT DIP GALVANISED

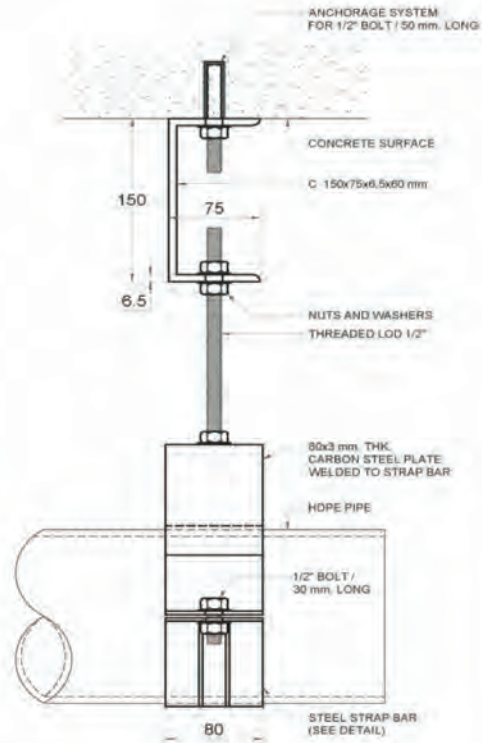
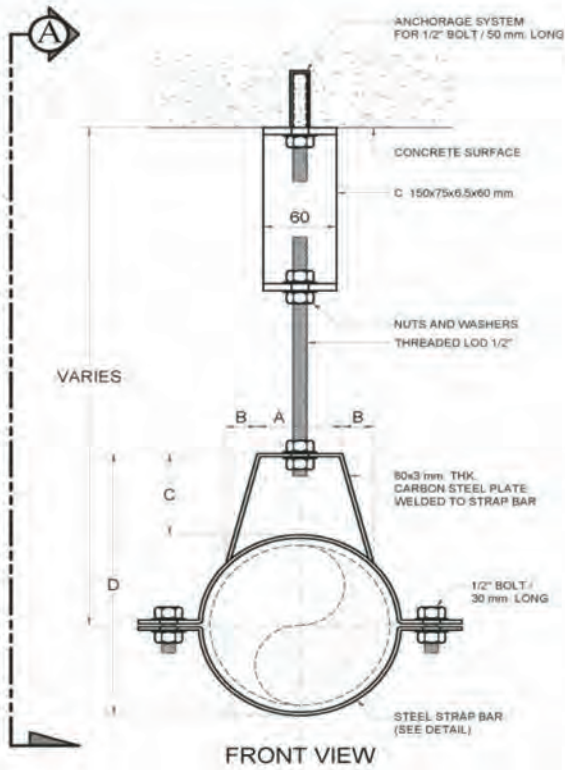

HDPE PIPE CLAMP - TYPE A
HOT DIP GALVANISED

CODE	OD. PIPE	THICKNESS	PRICE
HHDPEPCA01	160	3.00	340.00
HHDPEPCA02	200	3.00	420.00
HHDPEPCA03	225	3.00	500.00
HHDPEPCA04	250	4.00	820.00
HHDPEPCA05	280	4.00	950.00
HHDPEPCA06	315	5.00	1,200.00

C SUPPORT
HOT DIP GALVANISED

CODE	DIMENSION	PRICE
HUSPT01	150x75xL60xT6.5	280.00
HUSPT02	100x50x150LxT5.0xT7.5	350.00

HDPE PIPE CLAMP - TYPE C
HOT DIP GALVANISED

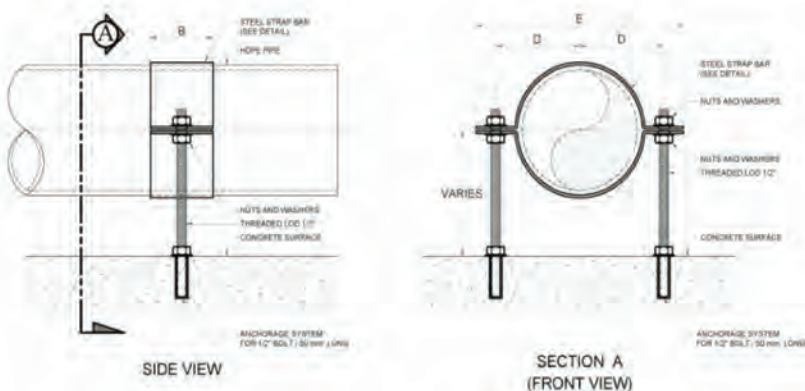

CODE	OD. PIPE	PRICE
HHDPEPCB01	160	290.00
HHDPEPCB02	200	357.00
HHDPEPCB03	225	425.00
HHDPEPCB04	250	697.00
HHDPEPCB05	280	807.50
HHDPEPCB06	315	1,020.00

HDPE PIPE CLAMP SET - TYPE B
HOT DIP GALVANISED

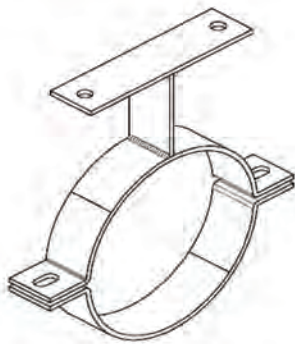

RAW MATERIAL : COLD ROLLED TEEL
FINISHING : ZINC HOT DIP GALVANISED

CODE	OD. PIPE	THICKNESS	PRICE
HHDPEPCB01	160	3.00	480.00
HHDPEPCB02	200	3.00	550.00
HHDPEPCB03	225	3.00	650.00
HHDPEPCB04	250	4.00	750.00
HHDPEPCB05	280	4.00	900.00
HHDPEPCB06	315	5.00	980.00

WIREWAY HANGER
HOT DIP GALVANISED



RAW MATERIAL : COLD ROLLED TEEL
FINISHING : ZINC HOT DIP GALVANISED

CODE	SIZE	THICKNESS	PRICE
WWH-HD01	75 x 50	1.6	95
WWH-HD02	100 x 50	1.6	115
WWH-HD03	100 x 75	1.6	120
WWH-HD04	100 x 100	1.6	125
WWH-HD05	150 x 100	1.6	140
WWH-HD06	200 x 100	1.6	165
WWH-HD07	250 x 100	1.6	PLEASE ASK FOR QOUTATION
WWH-HD08	300 x 100	2	
WWH-HD09	350 x 100	2	
WWH-HD10	400 x 100	2	
WWH-HD11	450 x 100	2	
WWH-HD12	500 x 100	2	
WWH-HD13	550 x 100	2.5	
WWH-HD14	600 x 100	2.5	
WWH-HD15	700 x 100	2.5	

STEEL PLATE
HOT DIP GALVANISED

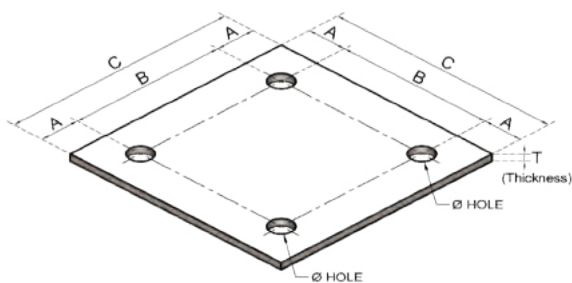

MADE TO ORDER
RAW MATERIAL : COLD ROLLED TEEL
PROCESS : LASER CUTTING
FINISHING : ZINC HOT DIP GALVANISED

HOT DIP GALVANISED DRAINAGE PIPE CLAMP AND SUPPORT

U CHANNEL HOT DIP GALVANISED

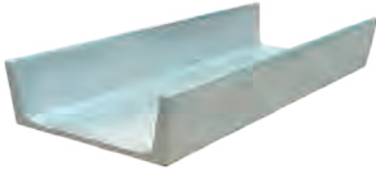

OPTION CUT TO SIZE OR 6 m
FINISHING HOT DIP GALVANISED

CODE	THICKNESS	SIZE (W x H)
UC50255H	5 x 6	50 x 25
UC75405H	5 x 7	75 x 40
UC10505H	5 x 7.5	100 x 50
UC125656H	6 x 8	125 x 65
UC150756H	6.5 x 10	150 x 75
UC150759H	9 x 12.5	150 x 75

EQUAL ANGLE STEEL HOT DIP GALVANISED

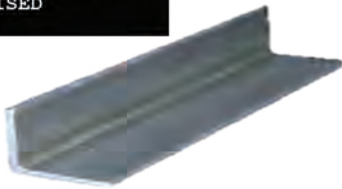

OPTION CUT TO SIZE OR 6 m
FINISHING HOT DIP GALVANISED

CODE	THICKNESS	DIMENSION (W x L)
HEQS330L05	3	30 x 500
HEQS330L10	3	30 x 1000
HEQS330L15	3	30 x 1500
HEQS450L05	4	50 x 500
HEQS450L10	4	50 x 1000
HEQS450L15	4	50 x 1500
HEQS550L05	5	50 x 500
HEQS550L10	5	50 x 1000
HEQS550L15	5	50 x 1500
HEQS650L05	6	50 x 500
HEQS650L10	6	50 x 1000
HEQS650L15	6	50 x 1500
HEQS865L05	8	65 x 500
HEQS865L10	8	65 x 1000
HEQS865L15	8	65 x 1500

STRUT CHANNEL HOT DIP GALVANISED



SHEET STEEL
ZINC HOT DIP GALVANISED

CODE	THICKNESS	DIMENSION (C x D x L)
CCN25HDG24	2.5	25 x 40 x 2400
CCND25HDG24	2.5	41.2 x 41.2 x 2400
CCN25HDG30	2.5	25 x 40 x 3000
CCND25HDG30	2.5	41.2 x 41.2 x 3000
CCN25HDG40	2.5	25 x 40 x 4000
CCND25HDG40	2.5	41.2 x 41.2 x 4000
CCN30HDG24	3	25 x 40 x 2400
CCND30HDG24	3	41.2 x 41.2 x 2400
CCN30HDG30	3	25 x 40 x 3000
CCND30HDG30	3	41.2 x 41.2 x 3000
CCN30HDG40	3	25 x 40 x 4000
CCND30HDG40	3	41.2 x 41.2 x 4000

SPRING NUT HOT DIP GALVANISED

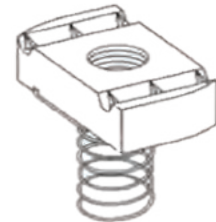

HOT ROLLED STEEL
ZINC HOT DIP GALVANISED

CODE	THICKNESS	HOLE
HSPR14	6	1/4"
HSPR516	8	5/16"
HSPR38	9.2	3/8"
HSPR12	12	1/2"
HSPR58	12	3/4"

STRUT FITTINGS
HOT DIP GALVANISED

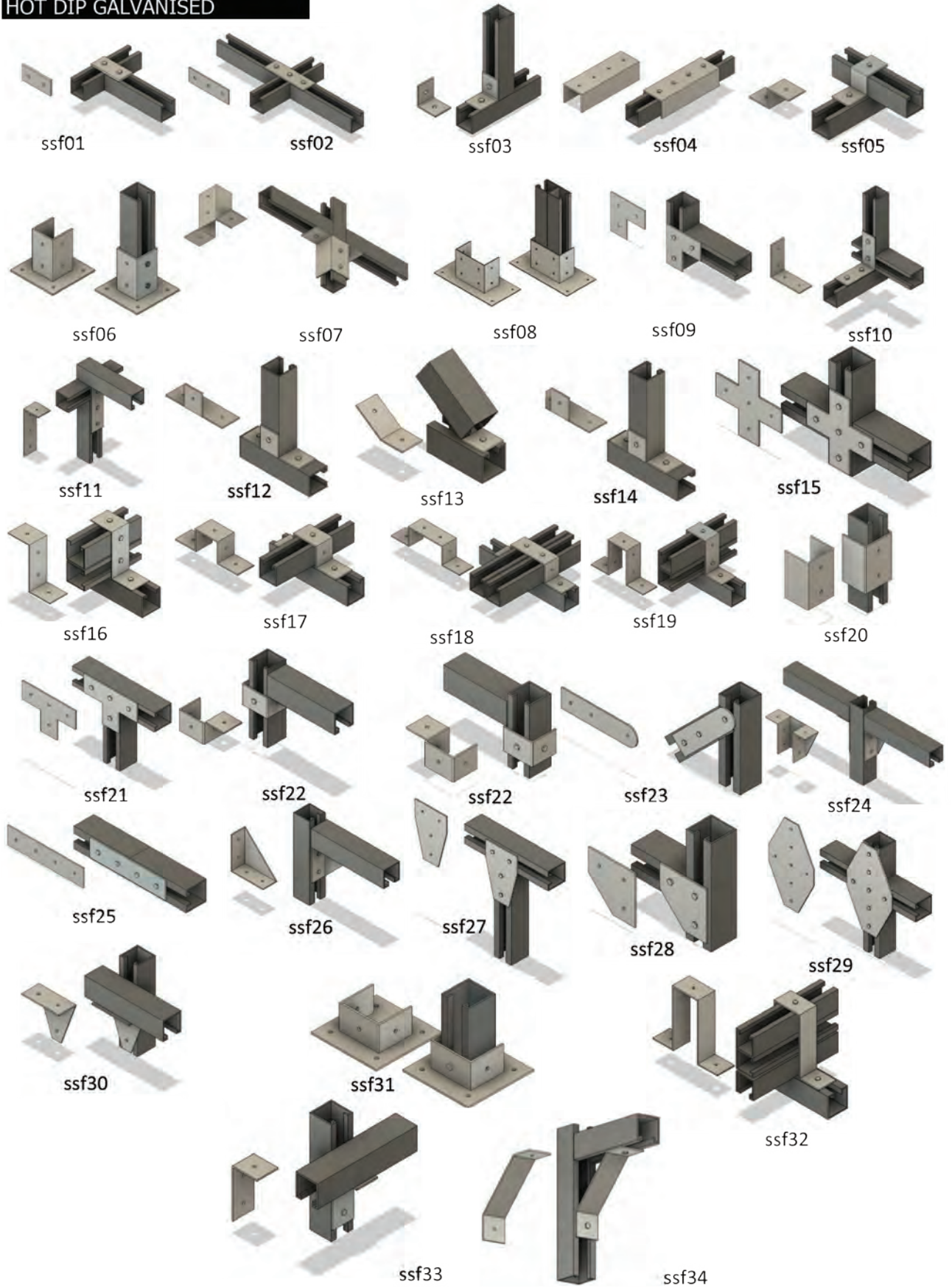

STRUT FITTINGS

HOT DIP GALVANISED

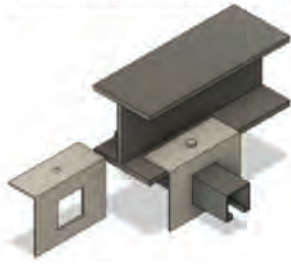

ssf35

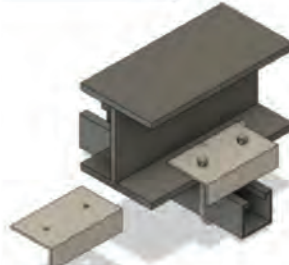

ssf36

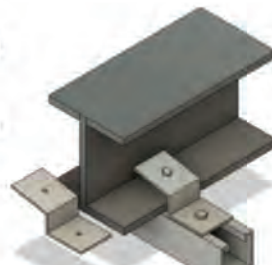

ssf37

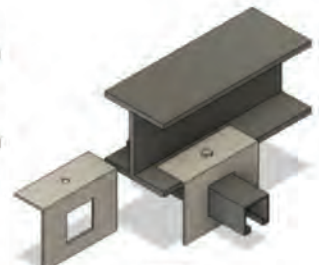

ssf38

STRUT CHANNEL

HOT DIP GALVANISED

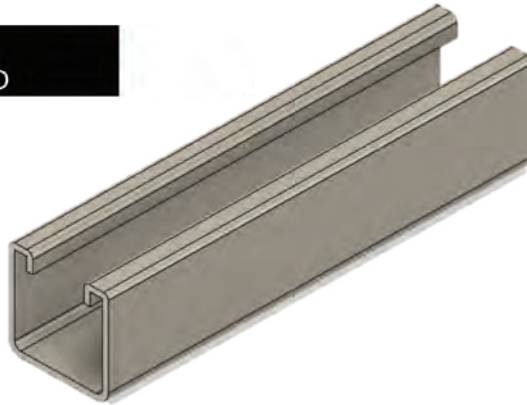

CODE	SIZE	PRICE
CCND25HDG30	41.2 x 41.2 x 3000L x 2.5	2,000.00
CCND25HDG60	41.2 x 41.2 x 6000L x 2.5	4,000.00

DOUBLE STRUT CHANNEL

HOT DIP GALVANISED



CODE	SIZE	PRICE
DCCND25HDG30	82.4 x 41.2 x 3000L x 2.5	4,800.00
DCCND25HDG60	82.4 x 41.2 x 6000L x 2.5	9,600.00

HOT DIP GALVANISED TUNNEL HANGER SUPPORT

TUNNEL CABLE SUPPORT

HOT DIP GALVANISED

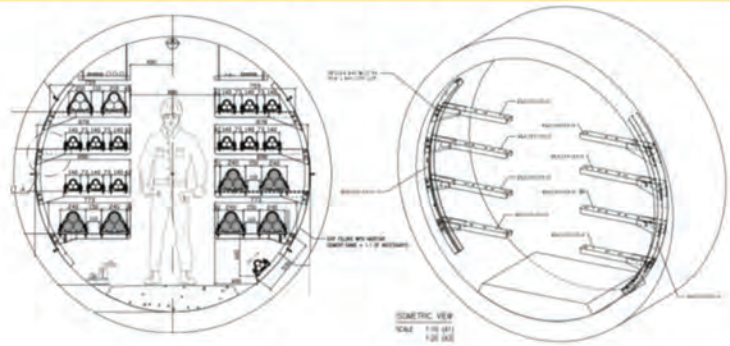

CODE	DIMENSION
TCHS0H	
THS02H	
THS03H	
THS04H	
THS05H	
THS06H	
THS01H	

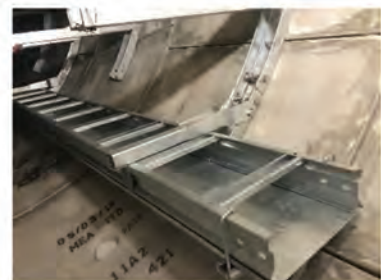

HOT DIP GALVANISED HANGER AND SUPPORT FOR MECHANICAL WORK

U BOLT HOT DIP GALVANISED



RAW MATERIAL : STEEL ROD
FINISHING : ZINC HOT DIP GALVANISED

CODE	SIZE	PRICE
HUBLT01	1/2"	15.00
HUBLT02	3/4"	18.00
HUBLT03	1"	22.00
HUBLT04	1 1/4"	25.00
HUBLT05	1 1/2"	29.00
HUBLT06	2"	40.00
HUBLT07	2 1/2"	44.00
HUBLT08	3"	58.00
HUBLT09	3 1/2"	62.00
HUBLT10	4"	66.00
HUBLT11	5"	88.00
HUBLT12	6"	108.00
HUBLT13	8"	138.00

UB CLAMP HOT DIP GALVANISED



RAW MATERIAL : COLD ROLLED STEEL
FINISHING : ZINC HOT DIP GALVANISED

CODE	SIZE	PRICE
HUBC01	25 mm	700.00

SUBFRAME SUPPORT HOT DIP GALVANISED



RAW MATERIAL : COLD ROLLED STEEL
FINISHING : ZINC HOT DIP GALVANISED

CODE	THICKNESS	SIZE	PRICE
HFB0505	3	50 x 50	150.00
HFB0510	3	50 x 100	200.00
HFB0813	3	80 x 130	250.00
HFB1515	3	150 x 150	330.00

PIPE STRAPS HOT DIP GALVANISED

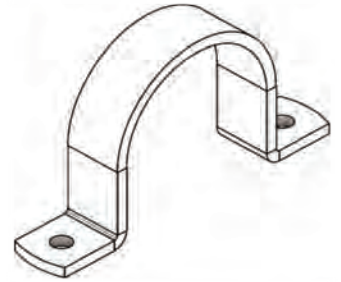

CODE	SIZE	PRICE
HPSP01	1/2"	60.00
HPSP02	3/4"	70.00
HPSP03	1"	85.00
HPSP04	1 1/4"	100.00
HPSP05	1 1/2"	130.00
HPSP06	2"	180.00
HPSP07	2 1/2"	250.00
HPSP08	3"	350.00
HPSP09	4"	450.00
HPSP10	5"	550.00
HPSP11	6"	600.00
HPSP12	8"	800.00

CLEVIS HANGER
HOT DIP GALVANISED

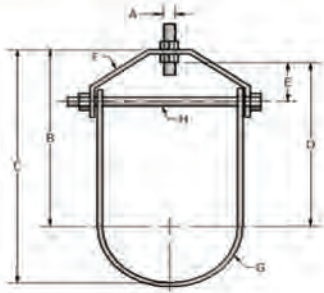

CODE	SIZE	PRICE
HCVH01	2"	62
HCVH02	2 1/2"	94
HCVH03	3"	124
HCVH04	4"	140
HCVH05	5"	206
HCVH06	6"	290
HCVH07	8"	430
HCVH08	10"	790
HCVH09	12"	800

BAND HANGER
HOT DIP GALVANISED



CODE	OD. PIPE	PRICE
HABH01	1/2"	33
HABH02	3/4"	37
HABH03	1"	40
HABH04	1 1/4"	42
HABH05	1 1/2"	45
HABH06	2"	48
HABH07	2 1/2"	55
HABH08	3"	60
HABH09	4"	65
HABH10	5"	120
HABH11	6"	130
HABH12	8"	218

STRAP U BOLT
HOT DIP GALVANISED

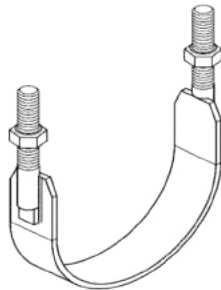

CODE	OD. PIPE	PRICE
HSUB01	2"	67
HSUB02	2 1/2"	112
HSUB03	3"	120
HSUB04	4"	220
HSUB05	5"	300
HSUB06	6"	330
HSUB07	8"	360
HSUB08	10"	390
HSUB09	12"	420

SPLIT RING HANGER
HOT DIP GALVANISED



CODE	PIPE SIZE	PRICE
HSRH01	1/2"	34
HSRH02	3/4"	36
HSRH03	1"	38
HSRH04	1 1/4"	40
HSRH05	1 1/2"	42
HSRH06	2"	46
HSRH07	2 1/2"	52
HSRH08	3"	60
HSRH09	4"	66
HSRH010	6"	174
HSRH011	8"	290

HOT DIP GALVANISED
ELECTRICAL
TRUNKING SYSTEM

CABLE TRAY
HOT DIP GALVANISED



RAW MATERIAL SHEET STEEL
FINISHING Zn HOT DIP GALVANISED
LENGTH 3000

CODE	SIZE	THICKNESS	PRICE
HCBT010	100 x 100	1.6	1,640.00
HCBT015	150 x 100	1.6	1,900.00
HCBT020	200 x 100	1.6	2,156.00
HCBT025	250 x 100	1.6	2,414.00
HCBT030	300 x 100	1.6	2,666.00
HCBT035	350 x 100	1.6	2,924.00
HCBT040	400 x 100	1.6	3,180.00
HCBT045	450 x 100	1.6	3,438.00
HCBT050	500 x 100	1.6	3,694.00

REDUCER
HOT DIP GALVANISED

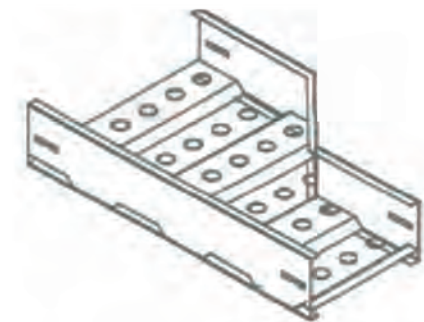

RAW MATERIAL SHEET STEEL
FINISHING Zn HOT DIP GALVANISED

CODE	SIZE	THICKNESS	PRICE
HCTR030	300 x 100	1.6	1,040.00
HCTR040	400 x 100	1.6	1,275.00
HCTR050	500 x 100	1.6	1,480.00
HCTR060	600 x 100	1.6	1,585.00
HCTR070	700 x 100	1.6	1,800.00
HCTR080	800 x 100	1.6	2,000.00
HCTR090	900 x 100	1.6	2,250.00
HCTR100	1000 x 100	1.6	2,730.00

90 HORIZONTAL BEND
HOT DIP GALVANISED

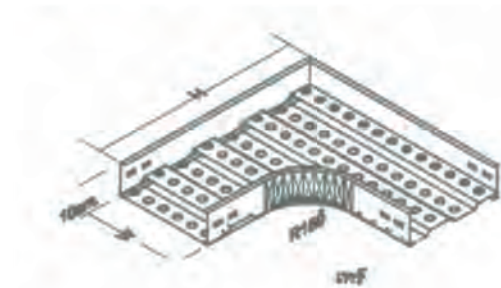

RAW MATERIAL SHEET STEEL
FINISHING Zn HOT DIP GALVANISED

CODE	SIZE	THICKNESS	PRICE
HCTB010	100 x 100	1.6	1,080.00
HCTB015	150 x 100	1.6	1,220.00
HCTB020	200 x 100	1.6	1,380.00
HCTB025	250 x 100	1.6	1,550.00
HCTB030	300 x 100	1.6	1,700.00
HCTB035	350 x 100	1.6	1,890.00
HCTB040	400 x 100	1.6	2,080.00
HCTB045	500 x 100	1.6	2,280.00
HCTB050	550 x 100	1.6	2,500.00

HORIZONTAL TEE
HOT DIP GALVANISED

RAW MATERIAL SHEET STEEL
FINISHING Zn HOT DIP GALVANISED

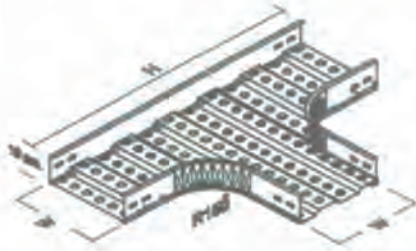

CODE	SIZE	THICKNESS	PRICE
HCTTE010	100 x 100	1.6	1,540.00
HCTTE015	150 x 100	1.6	1,730.00
HCTTE020	200 x 100	1.6	1,960.00
HCTTE025	250 x 100	1.6	2,202.00
HCTTE030	300 x 100	1.6	2,414.00
HCTTE035	350 x 100	1.6	2,684.00
HCTTE040	400 x 100	1.6	2,954.00
HCTTE045	450 x 100	1.6	3,240.00
HCTTE050	500 x 100	1.6	3,550.00

HORIZONTAL CROSS
HOT DIP GALVANISED

RAW MATERIAL SHEET STEEL
FINISHING Zn HOT DIP GALVANISED

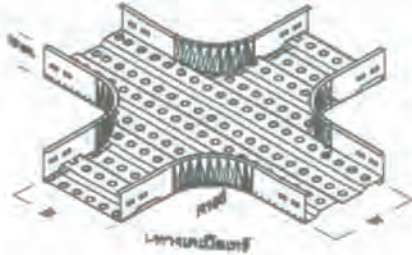

CODE	SIZE	THICKNESS	PRICE
HCTCR010	100 x 100	1.6	2,404.00
HCTCR015	150 x 100	1.6	2,590.00
HCTCR020	200 x 100	1.6	2,782.00
HCTCR025	250 x 100	1.6	2,988.00
HCTCR030	300 x 100	1.6	3,196.00
HCTCR035	350 x 100	1.6	3,420.00
HCTCR040	400 x 100	1.6	3,650.00
HCTCR045	450 x 100	1.6	3,890.00
HCTCR050	500 x 100	1.6	4,130.00

VERTICAL BEND
HOT DIP GALVANISED

RAW MATERIAL SHEET STEEL
FINISHING Zn HOT DIP GALVANISED

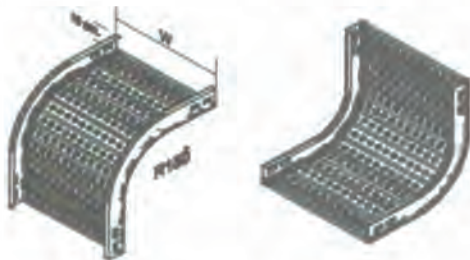

CODE	SIZE	THICKNESS	PRICE
HCTVB010	100 x 100	1.6	756.00
HCTVB015	150 x 100	1.6	854.00
HCTVB020	200 x 100	1.6	966.00
HCTVB025	250 x 100	1.6	1,086.00
HCTVB030	300 x 100	1.6	1,190.00
HCTVB035	350 x 100	1.6	1,324.00
HCTVB040	400 x 100	1.6	1,456.00
HCTVB045	500 x 100	1.6	1,596.00
HCTVB050	600 x 100	1.6	1,750.00

WIREWAY
HOT DIP GALVANISED

RAW MATERIAL SHEET STEEL
 LENGTH 2440
 FINISHING Zn HOT DIP GALVANISED

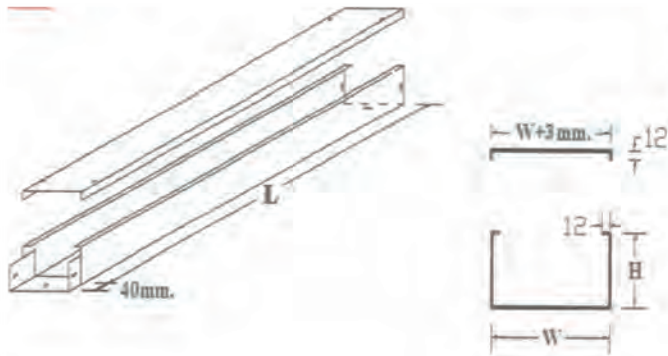

CODE	SIZE	THICKNESS	PRICE
HWW1050	100 x 50	1.6	1,340.00
HWW1550	150 x 50	1.6	1,730.00
HWW1010	100 x 100	1.6	1,730.00
HWW1510	150 x 100	1.6	2,120.00
HWW2010	200 x 100	1.6	2,500.00
HWW3010	300 x 100	1.6	3,280.00
HWW4010	400 x 100	1.6	4,050.00

HORIZONTAL BEND
HOT DIP GALVANISED

RAW MATERIAL SHEET STEEL
 FINISHING Zn HOT DIP GALVANISED

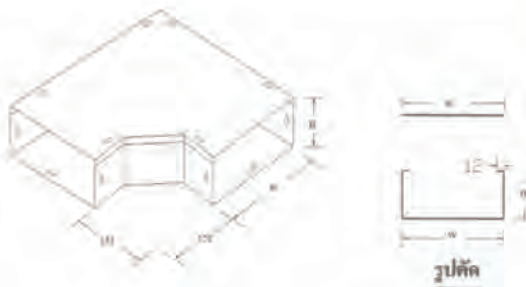

CODE	SIZE	THICKNESS	PRICE
HBN1050	100 x 50	1.6	380.00
HBN1550	150 x 50	1.6	580.00
HBN1010	100 x 100	1.6	580.00
HBN1510	150 x 100	1.6	750.00
HBN2010	200 x 100	1.6	880.00
HBN3010	300 x 100	1.6	1,150.00
HBN4010	400 x 100	1.6	1,600.00

HORIZONTAL TEE
HOT DIP GALVANISED

RAW MATERIAL SHEET STEEL
FINISHING Zn HOT DIP GALVANISED

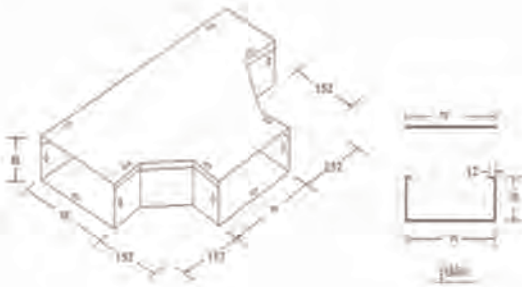

CODE	SIZE	THICKNESS	PRICE
HTEE1050	100 x 50	1.6	475.00
HTEE1550	150 x 50	1.6	725.00
HTEE1010	100 x 100	1.6	725.00
HTEE1510	150 x 100	1.6	940.00
HTEE2010	200 x 100	1.6	1,100.00
HTEE3010	300 x 100	1.6	1,440.00
HTEE4010	400 x 100	1.6	2,000.00

HORIZONTAL CROSS
HOT DIP GALVANISED

RAW MATERIAL SHEET STEEL
FINISHING Zn HOT DIP GALVANISED

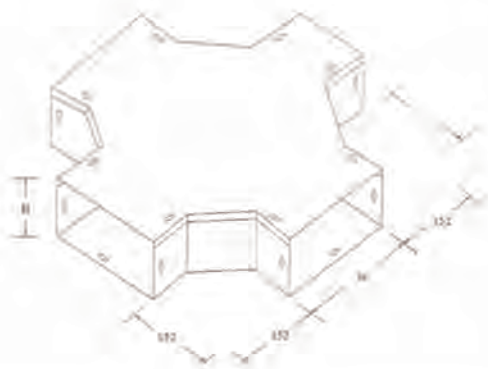

CODE	SIZE	THICKNESS	PRICE
HCRS1050	100 x 50	1.6	590.00
HCRS1550	150 x 50	1.6	905.00
HCRS1010	100 x 100	1.6	905.00
HCRS1510	150 x 100	1.6	1,175.00
HCRS2010	200 x 100	1.6	1,375.00
HCRS3010	300 x 100	1.6	1,800.00
HCRS4010	400 x 100	1.6	2,500.00

**VERTICAL BEND
HOT DIP GALVANISED**

RAW MATERIAL SHEET STEEL
FINISHING Zn HOT DIP GALVANISED

CODE	SIZE	THICKNESS	PRICE
HVBN 1050	100 x 50	1.6	380.00
HVBN 1550	150 x 50	1.6	580.00
HVBN 1010	100 x 100	1.6	580.00
HVBN 1510	150 x 100	1.6	750.00
HVBN 2010	200 x 100	1.6	880.00
HVBN 3010	300 x 100	1.6	1,150.00
HVBN 4010	400 x 100	1.6	1,600.00

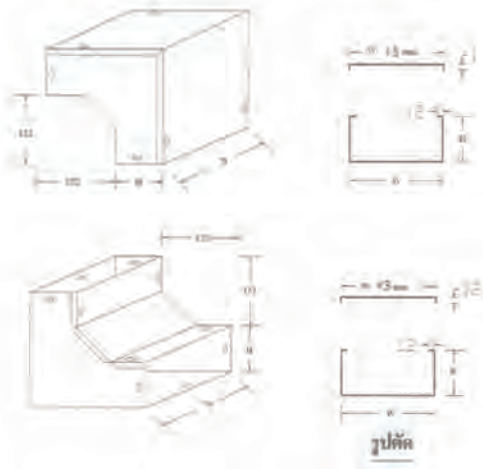

CABLE LADDER
HOT DIP GALVANISED

RAW MATERIAL SHEET STEEL
FINISHING Zn HOT DIP GALVANISED
LENGTH 3000

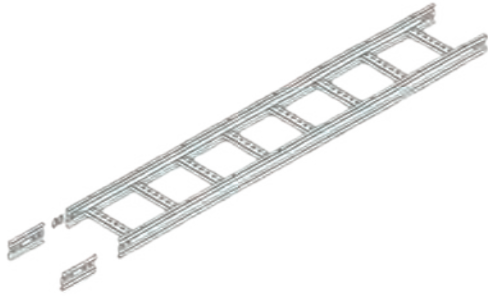

CODE	SIZE	THICKNESS	PRICE
HLDD010	100 x 100	1.6	1,303.00
HLDD020	200 x 100	1.6	1,564.00
HLDD030	300 x 100	1.6	1,708.00
HLDD040	400 x 100	1.6	1,854.00
HLDD050	500 x 100	1.6	2,000.00
HLDD060	600 x 100	1.6	2,144.00
HLDD070	700 x 100	1.6	2,292.00
HLDD080	800 x 100	1.6	2,438.00
HLDD090	900 x 100	1.6	2,584.00
HLDD100	1000x 100	1.6	2,732.00

90 HORIZONTAL BEND
HOT DIP GALVANISED

RAW MATERIAL SHEET STEEL
FINISHING Zn HOT DIP GALVANISED



CODE	SIZE	THICKNESS	PRICE
HLDB010	100 x 100	1.6	595.00
HLDB020	200 x 100	1.6	714.00
HLDB030	300 x 100	1.6	840.00
HLDB040	400 x 100	1.6	1,040.00
HLDB050	500 x 100	1.6	1,160.00
HLDB060	600 x 100	1.6	1,298.00
HLDB070	700 x 100	1.6	1,554.00
HLDB080	800 x 100	1.6	1,710.00
HLDB090	900 x 100	1.6	1,878.00
HLDB100	1000 x 100	1.6	2,200.00

HORIZONTAL TEE
HOT DIP GALVANISED

RAW MATERIAL SHEET STEEL
FINISHING Zn HOT DIP GALVANISED

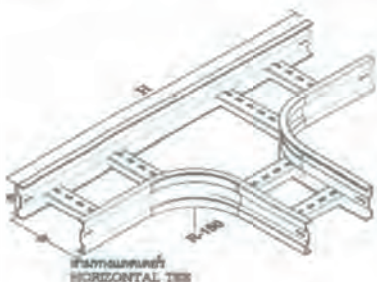

CODE	SIZE	THICKNESS	PRICE
HLDTE010	100 x 100	1.6	743.00
HLDTE020	200 x 100	1.6	892.00
HLDTE030	300 x 100	1.6	1,050.00
HLDTE040	400 x 100	1.6	1,300.00
HLDTE050	500 x 100	1.6	1,450.00
HLDTE060	600 x 100	1.6	1,622.00
HLDTE070	700 x 100	1.6	1,942.00
HLDTE080	800 x 100	1.6	2,138.00
HLDTE090	900 x 100	1.6	2,348.00
HLDTE100	1000x 100	1.6	2,750.00

HORIZONTAL CROSS
 HOT DIP GALVANISED

RAW MATERIAL SHEET STEEL
 FINISHING Zn HOT DIP GALVANISED

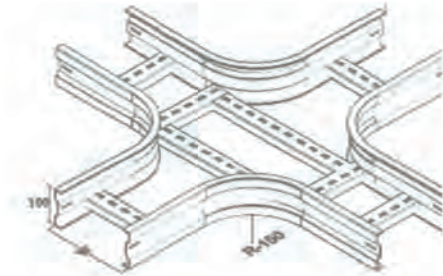

CODE	SIZE	THICKNESS	PRICE
HLDCR010	100 x 100	1.6	933.00
HLDCR020	200 x 100	1.6	1,120.00
HLDCR030	300 x 100	1.6	1,320.00
HLDCR040	400 x 100	1.6	1,630.00
HLDCR050	500 x 100	1.6	1,840.00
HLDCR060	600 x 100	1.6	2,010.00
HLDCR070	700 x 100	1.6	2,310.00
HLDCR080	800 x 100	1.6	2,494.00
HLDCR090	900 x 100	1.6	2,670.00
HLDCR100	1000 x 100	1.6	3,030.00

VERTICAL BEND
 HOT DIP GALVANISED

RAW MATERIAL SHEET STEEL
 FINISHING Zn HOT DIP GALVANISED

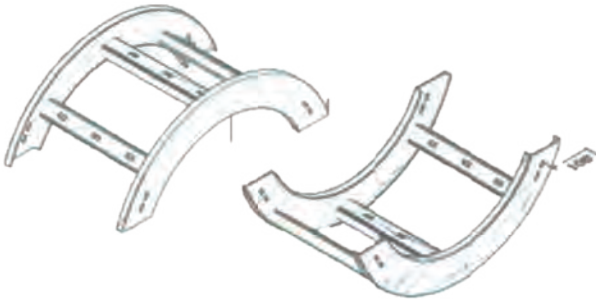

CODE	SIZE	THICKNESS	PRICE
HLDCR010	100 x 100	1.6	493.00
HLDCR020	200 x 100	1.6	592.00
HLDCR030	300 x 100	1.6	700.00
HLDCR040	400 x 100	1.6	820.00
HLDCR050	500 x 100	1.6	900.00
HLDCR060	600 x 100	1.6	976.00
HLDCR070	700 x 100	1.6	1,030.00
HLDCR080	800 x 100	1.6	1,120.00
HLDCR090	900 x 100	1.6	1,200.00
HLDCR100	1000 x 100	1.6	1,290.00

HDPE CONDUIT & FITTING



HDPE CONDUIT

RAW MATERIAL	เม็ดพลาสติก HDPE ที่ผ่านการรับรองมาตรฐาน S2559-2554 (PE80, PE100)
USABILITY	ร้อยสายไฟฟ้าและ สายสัญญาณ, HDD
PRESSURE CLASS	PE80&100 / CLASS-1, PN3.2 - PN25 (BAR)
SIZE	DIA 20mm. - 1200 mm.
STANDARD	TIS982 - 2556, DIN8074/75 - 1999, ISO 4427:2007, SFS 4231/4232, AS/NSZ 4130:2009, BS EN 12201:2011
APPARENCE	ผิวท่อกาตสีส้ม/ขาว/เหลือง มีความมันเงา
PROPERTIES	ทนทานต่อแรงดัน ทนทานต่อแรงกดทับ ทนทานต่อแสง UV ทนทานต่อสภาพอากาศ ทนทานต่อสารเคมี

HDPE FITTING



ข้อต่อสวม PE
TYPE A

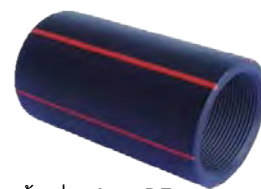

ข้อต่อสวม PE
TYPE B



ปากแตร
(BELL END)



ข้อโค้ง 90



ONE STOP SERVICE

ศูนย์รวมอุปกรณ์ไฟฟ้าและติดตั้งครบวงจร

ผู้ผลิตและจัดจำหน่ายอุปกรณ์ไฟฟ้าและส่วนประกอบที่ใช้ในการเชื่อมต่อท่อร้อยสายไฟ(Conduit Accessories & Fittings)

สินค้าคุณภาพ ง่ายต่อการติดตั้ง สะดวกรวดเร็ว งานเสร็จไว

CONTACT PERSON

MR.THONNAWAT VIROJWANICH

(FACTORY MANAGER)

TEL : (+66)83028-8899

EMAIL : THONNAWAT.ATC@GMAIL.COM

FAX : (+66)2464-1663



VISIT OUR WEBSITE